



Cajas de ventilación estancas, de bajo nivel sonoro, bajo perfil, fabricadas en chapa de acero galvanizado, con aislamiento acústico ininflamable (M0) de fibra de vidrio de 50 mm de espesor, silenciador acústico en la aspiración, juntas estancas en aspiración y descarga, cierres estancos de tipo tracción giratorio, de fácil apertura, y ventilador centrífugo de álabes hacia atrás. Motor brushless de corriente continua, de alto rendimiento y bajo consumo, alimentación 230V±15% 50/60Hz, IP44, rodamientos a bolas, protector térmico, interruptor ON/OFF con potenciómetro incorporado para ajustar la velocidad del 10 al 100% y entrada analógica para controlar el ventilador con una señal de 0-10V. Temperatura de trabajo de -20°C a +40°C.

#### Otros datos

Pueden ser colocadas en cualquier posición.  
Diseñadas para instalaciones en interior.



**Interruptor ON/OFF**  
con potenciómetro  
incorporado para ajustar la  
velocidad del 10 al 100%.



**Bajo nivel sonoro**  
Aislamiento acústico  
ininflamable (M0) de fibra  
de vidrio de 50 mm de  
espesor y revestimiento de  
alta resistencia, que reduce  
sensiblemente el ruido.



**Silenciador acústico en la  
aspiración.**



**Ventilador centrífugo de  
álabes hacia atrás.**

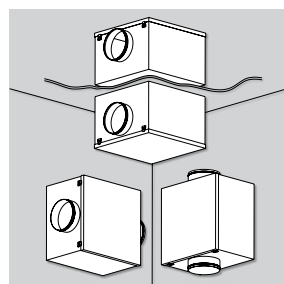

**Instalación en cualquier  
posición**  
Pueden ser instaladas  
en posición vertical,  
horizontal o invertidas.

### CARACTERÍSTICAS TÉCNICAS

Es imprescindible comprobar que las características eléctricas (voltaje, intensidad, frecuencia, etc.) del motor que aparecen en la placa del mismo son compatibles con las de la instalación.

Modelo	Tensión de control (V)	Velocidad (r.p.m.)	Potencia absorbida máxima (W)	Intensidad absorbida máxima (A)	Caudal máximo (m³/h)	Nivel de presión sonora* (dB(A) a 1,5 m)			Peso (kg)
						Descarga	Aspiración	Radiado	
CAB-125 ECOWATT	10	3900	75	0,5	400	46	51	37	13
	8	3550	57	0,4	355	44	49	35	
	6	2600	27	0,2	260	37	42	34	
	4	1800	12	0,1	185	28	33	25	
CAB-150 ECOWATT	10	3270	103	0,7	600	47	50	38	15
	8	2980	78	0,6	540	45	47	36	
	6	2300	38	0,3	410	39	41	33	
	4	1610	16	0,1	280	30	33	26	
CAB-160 ECOWATT	10	3270	102	0,7	590	47	51	41	15
	8	3020	81	0,5	530	45	49	40	
	6	2350	41	0,3	410	39	43	36	
	4	1620	18	0,1	280	30	34	27	
CAB-200 ECOWATT	10	2570	161	1,1	1.090	48	53	39	23
	8	2195	100	0,7	910	44	49	36	
	6	1715	50	0,4	710	37	43	31	
	4	1250	23	0,2	520	29	36	26	
CAB-250 ECOWATT	10	2650	219	1,4	1.220	52	58	42	24
	8	2390	162	1,1	1.100	47	50	29	
	6	1905	85	0,6	880	42	45	27	
	4	1410	40	0,3	660	37	38	21	
CAB-315 ECOWATT	10	1990	238	1,0	1.910	54	57	52	28
	8	1670	143	0,6	1.610	50	53	48	
	6	1390	88	0,4	1.360	45	48	40	
	4	1060	46	0,2	1.010	38	42	35	
CAB-355 ECOWATT	10	1940	335	1,4	2.580	54	58	49	32
	8	1685	224	1,0	2.260	52	55	46	
	6	1380	130	0,6	1.840	50	50	39	
	4	1070	69	0,3	1.440	40	43	33	
CAB-400 ECOWATT	10	1940	335	1,4	2.650	54	55	48	32
	8	1695	229	1,1	2.320	50	53	48	
	6	1380	131	0,6	1.900	45	48	40	
	4	1070	68	0,3	1.460	38	42	35	

\* Punto medio de la curva.

### DIMENSIONES (mm)

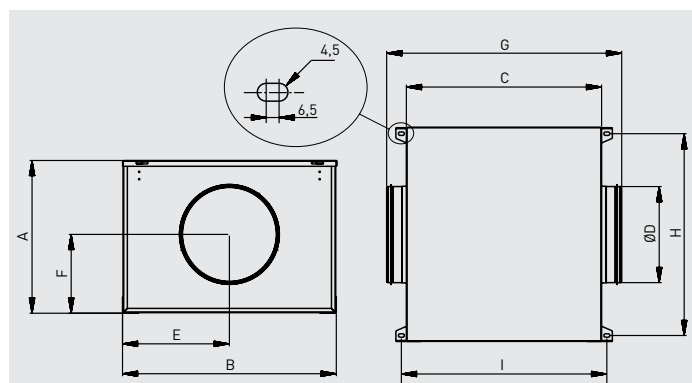

Modelo	A	B	C	D	E	F	G	H	I
CAB-125 ECOWATT	316	420	386	125	210	163	433	389	412
CAB-150 ECOWATT	334	447	415	150	224	174	517	416	441
CAB-160 ECOWATT	334	447	415	160	224	174	517	416	441
CAB-200 ECOWATT	375	510	468	200	255	193	570	479	494
CAB-250 ECOWATT	395	553	505	250	277	204	608	522	535
CAB-315 ECOWATT	441	609	555	315	305	221	659	585	580
CAB-355 ECOWATT	501	699	578	355	350	251	682	668	606
CAB-400 ECOWATT	501	699	578	400	350	251	682	668	606

### CURVAS CARACTERÍSTICAS

- $q_v$  = Caudal en  $m^3/h$ .
- $p_{sf}$  = Presión estática en mmca y Pa.
- SFP: Factor específico de potencia en  $W/m^3/s$  (curvas azules).
- Aire seco normal a  $20^\circ C$  y  $760$  mmHg.
- Ensayos realizados de acuerdo a Norma ISO 5801 y AMCA 210-99.

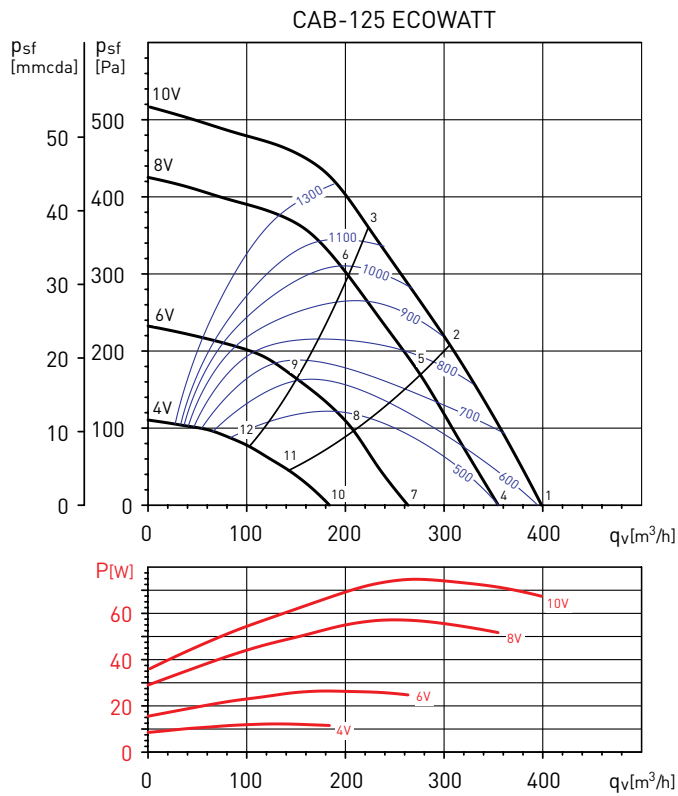

### Espectros de potencia en dB(A)

Punto de trabajo		63	125	250	500	1.000	2.000	4.000	8.000	LwA
1	Aspiración	39	47	52	60	61	60	55	57	66
	Descarga	40	49	50	51	56	57	55	48	62
	Radiado	40	47	46	43	41	44	42	40	53
2	Aspiración	37	44	52	60	61	57	54	55	65
	Descarga	38	47	47	49	54	56	53	46	60
	Radiado	37	44	46	43	40	42	41	38	51
3	Aspiración	34	42	53	59	61	56	52	53	65
	Descarga	35	44	47	48	53	55	52	45	59
	Radiado	35	42	47	42	41	41	40	36	51
4	Aspiración	39	44	50	57	59	57	53	54	64
	Descarga	47	46	47	49	53	54	52	45	59
	Radiado	37	44	45	41	38	42	40	38	50
5	Aspiración	38	42	50	57	59	55	51	52	63
	Descarga	47	45	45	47	51	53	50	42	58
	Radiado	35	42	45	42	38	39	38	35	49
6	Aspiración	37	41	51	56	59	54	50	49	62
	Descarga	47	43	45	46	50	53	49	42	57
	Radiado	34	40	46	40	38	38	37	33	49
7	Aspiración	36	40	49	52	52	51	48	44	58
	Descarga	35	41	46	42	46	47	44	34	53
	Radiado	38	39	45	37	37	39	36	32	48
8	Aspiración	36	38	50	51	51	49	46	41	57
	Descarga	35	41	45	41	44	46	42	31	52
	Radiado	38	37	46	37	35	37	34	29	48
9	Aspiración	36	38	48	52	50	48	43	39	56
	Descarga	34	41	44	40	44	48	41	32	52
	Radiado	38	37	44	38	35	36	32	27	47
10	Aspiración	24	31	36	42	43	43	37	26	48
	Descarga	25	33	34	33	36	39	34	23	43
	Radiado	23	32	33	30	30	32	33	25	40
11	Aspiración	24	31	37	42	42	40	33	26	47
	Descarga	24	32	34	32	33	37	31	23	42
	Radiado	23	32	33	30	28	29	29	25	39
12	Aspiración	23	30	35	42	41	38	30	25	46
	Descarga	24	33	34	33	35	37	29	23	42
	Radiado	22	32	32	30	28	27	25	24	38

### CURVAS CARACTERÍSTICAS

- $q_v$  = Caudal en  $m^3/h$ .
- $p_{sf}$  = Presión estática en mmca y Pa.
- SFP: Factor específico de potencia en  $W/m^3/s$  (curvas azules).
- Aire seco normal a  $20^\circ C$  y  $760$  mmHg.
- Ensayos realizados de acuerdo a Norma ISO 5801 y AMCA 210-99.

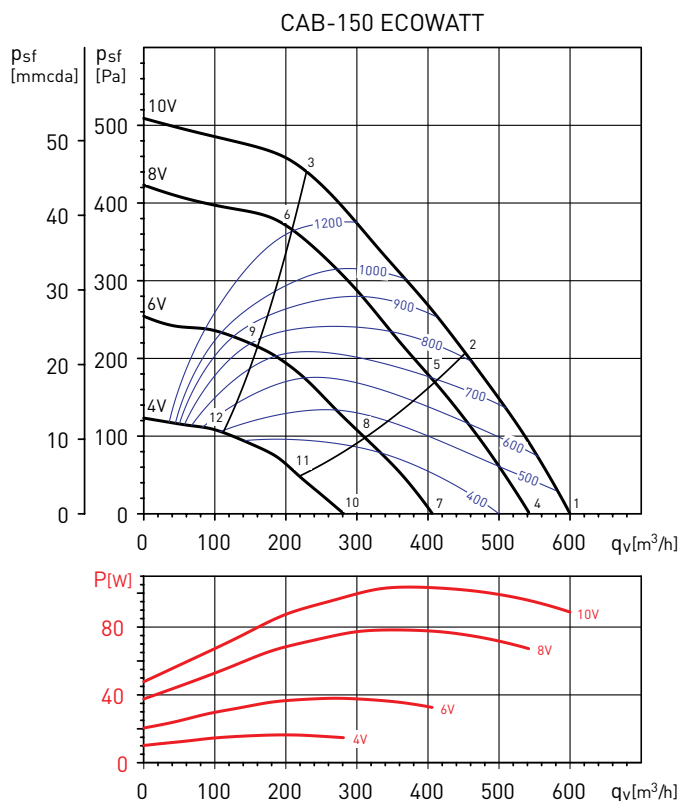

### Espectros de potencia en dB(A)

Punto de trabajo		63	125	250	500	1.000	2.000	4.000	8.000	LwA
1	Aspiración	43	49	53	59	61	59	58	51	66
	Descarga	44	52	52	53	57	57	54	44	62
	Radiado	42	45	48	46	43	45	42	34	54
2	Aspiración	40	49	52	58	58	56	55	49	64
	Descarga	39	51	50	50	55	56	52	43	61
	Radiado	39	45	47	45	40	41	39	32	52
3	Aspiración	38	47	56	59	59	55	54	49	64
	Descarga	38	49	53	50	55	58	53	45	62
	Radiado	37	43	51	46	41	41	37	32	53
4	Aspiración	41	47	52	57	59	57	56	48	64
	Descarga	41	50	50	50	54	55	52	41	60
	Radiado	42	44	48	43	42	43	40	33	52
5	Aspiración	39	47	51	55	56	53	53	46	61
	Descarga	36	50	49	48	53	54	50	40	59
	Radiado	40	43	46	41	39	40	37	31	50
6	Aspiración	36	45	54	56	56	53	51	46	62
	Descarga	34	48	52	47	54	55	50	43	60
	Radiado	37	42	50	42	39	39	35	31	52
7	Aspiración	35	42	47	51	53	52	48	38	58
	Descarga	33	44	45	43	47	48	45	31	54
	Radiado	35	39	44	38	37	40	35	28	48
8	Aspiración	32	41	47	49	50	48	44	36	55
	Descarga	32	44	45	43	46	48	43	31	53
	Radiado	32	38	45	35	34	36	31	26	47
9	Aspiración	30	42	47	49	49	47	43	37	55
	Descarga	31	46	47	42	49	49	42	33	55
	Radiado	31	38	44	36	34	35	30	27	46
10	Aspiración	27	35	40	43	45	43	34	26	50
	Descarga	29	37	37	34	38	39	31	23	45
	Radiado	25	34	38	30	31	35	28	24	42
11	Aspiración	26	34	39	41	42	40	32	26	47
	Descarga	29	35	36	33	37	39	29	23	44
	Radiado	25	33	36	28	28	31	25	24	40
12	Aspiración	26	39	39	41	42	37	31	25	47
	Descarga	28	40	35	40	41	39	30	23	46
	Radiado	24	37	36	28	28	29	25	23	41

### CURVAS CARACTERÍSTICAS

- $q_v$  = Caudal en  $m^3/h$ .
- $p_{sf}$  = Presión estática en mmcda y Pa.
- SFP: Factor específico de potencia en  $W/m^3/s$  (curvas azules).
- Aire seco normal a  $20^\circ C$  y  $760$  mmHg.
- Ensayos realizados de acuerdo a Norma ISO 5801 y AMCA 210-99.

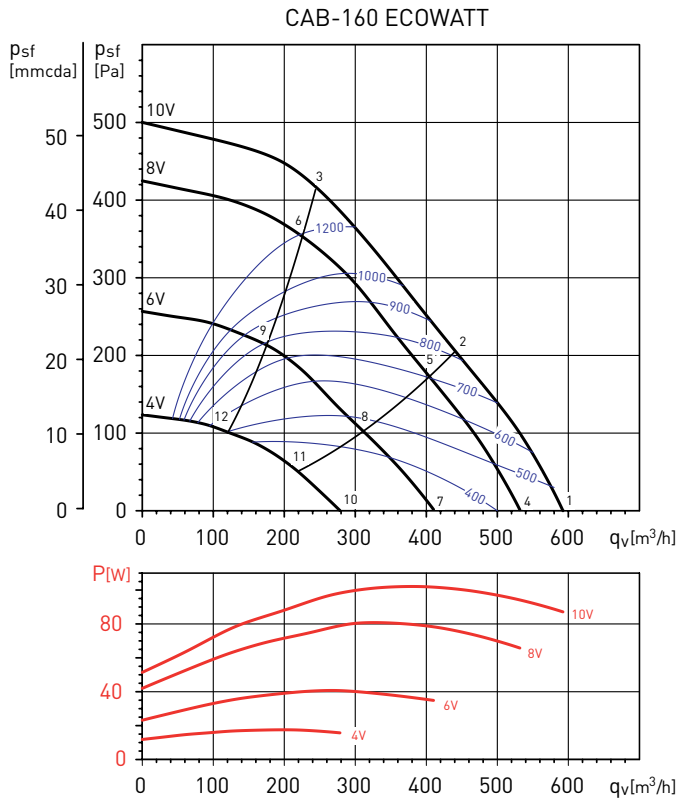

### Espectros de potencia en dB(A)

Punto de trabajo		63	125	250	500	1.000	2.000	4.000	8.000	LwA
1	Aspiración	41	48	54	62	63	61	57	50	67
	Descarga	44	51	51	52	55	58	55	45	62
	Radiado	44	46	48	46	50	52	51	42	57
2	Aspiración	38	46	54	60	60	57	54	48	65
	Descarga	38	49	48	50	54	56	53	43	60
	Radiado	41	44	47	44	46	48	48	40	55
3	Aspiración	34	45	54	60	59	56	52	48	65
	Descarga	36	47	50	49	53	55	52	45	60
	Radiado	37	43	48	44	46	47	46	40	54
4	Aspiración	39	46	53	59	61	59	55	47	65
	Descarga	41	49	50	49	53	56	53	42	60
	Radiado	40	45	47	44	49	51	49	40	56
5	Aspiración	36	44	53	57	57	55	52	45	63
	Descarga	36	48	48	47	52	54	51	41	59
	Radiado	38	43	46	42	45	47	46	38	53
6	Aspiración	34	44	53	58	57	54	50	45	63
	Descarga	34	46	49	47	51	53	50	43	58
	Radiado	35	43	46	43	45	46	44	38	53
7	Aspiración	32	41	49	53	55	53	48	38	60
	Descarga	32	43	45	42	47	50	46	32	54
	Radiado	35	41	43	40	43	46	43	33	51
8	Aspiración	29	38	47	51	51	49	43	36	56
	Descarga	29	42	44	41	46	49	44	32	53
	Radiado	32	38	41	38	39	41	38	31	47
9	Aspiración	27	37	48	52	51	49	43	37	57
	Descarga	28	44	45	41	45	47	42	34	52
	Radiado	30	37	42	39	40	41	38	32	48
10	Aspiración	25	36	39	45	47	46	33	25	51
	Descarga	25	36	38	34	38	40	31	23	45
	Radiado	17	29	31	38	39	38	26	18	44
11	Aspiración	25	35	38	43	44	42	31	25	48
	Descarga	32	35	34	33	38	39	30	23	44
	Radiado	18	27	30	35	36	34	23	17	41
12	Aspiración	21	35	37	43	43	39	31	25	48
	Descarga	22	37	34	33	38	38	31	24	44
	Radiado	14	27	30	35	35	32	23	17	40

### CURVAS CARACTERÍSTICAS

- $q_v$  = Caudal en  $m^3/h$ .
- $p_{sf}$  = Presión estática en mmca y Pa.
- SFP: Factor específico de potencia en  $W/m^3/s$  (curvas azules).
- Aire seco normal a  $20^\circ C$  y  $760$  mmHg.
- Ensayos realizados de acuerdo a Norma ISO 5801 y AMCA 210-99.

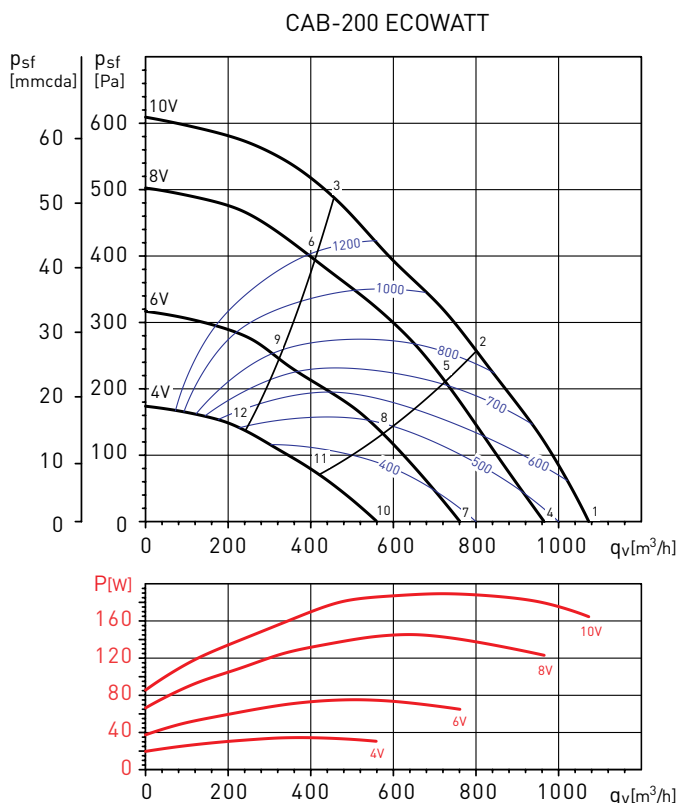

### Espectros de potencia en dB(A)

Punto de trabajo		63	125	250	500	1.000	2.000	4.000	8.000	LwA
1	Aspiración	50	53	63	65	68	61	63	60	72
	Descarga	49	57	57	56	60	61	56	50	66
	Radiado	52	44	49	46	50	47	44	50	58
2	Aspiración	44	49	61	61	63	58	62	58	69
	Descarga	43	53	54	53	58	59	55	50	64
	Radiado	46	40	47	42	45	43	43	48	54
3	Aspiración	38	48	66	65	65	59	62	58	71
	Descarga	38	50	57	52	56	60	55	50	64
	Radiado	40	40	53	46	47	45	42	48	56
4	Aspiración	47	50	61	62	65	59	61	57	69
	Descarga	46	54	55	53	58	59	54	46	64
	Radiado	50	42	47	44	48	45	42	51	56
5	Aspiración	42	46	60	59	61	56	59	55	67
	Descarga	41	50	52	51	55	57	53	47	62
	Radiado	45	38	46	40	44	42	40	49	53
6	Aspiración	35	48	64	62	63	57	59	55	69
	Descarga	36	48	55	50	54	58	52	49	62
	Radiado	38	39	50	44	46	43	40	49	55
7	Aspiración	42	44	56	57	59	53	55	46	64
	Descarga	39	48	51	48	52	53	48	36	58
	Radiado	43	36	44	39	43	39	36	41	50
8	Aspiración	36	42	53	54	56	51	53	47	61
	Descarga	35	44	48	46	50	52	49	38	57
	Radiado	38	34	42	36	40	36	35	41	47
9	Aspiración	31	49	56	56	57	51	52	47	62
	Descarga	32	46	49	46	49	52	50	42	57
	Radiado	32	41	45	38	40	37	34	41	49
10	Aspiración	33	39	46	50	51	47	45	35	56
	Descarga	31	40	40	43	46	46	38	27	51
	Radiado	35	34	38	34	36	34	30	24	43
11	Aspiración	29	38	45	49	49	45	44	36	54
	Descarga	29	38	38	41	45	46	37	26	50
	Radiado	30	32	36	32	33	32	29	25	41
12	Aspiración	26	43	48	49	49	43	44	35	55
	Descarga	30	45	42	41	43	46	42	30	51
	Radiado	28	38	39	33	34	31	28	25	43

### CURVAS CARACTERÍSTICAS

- $q_v$  = Caudal en  $m^3/h$ .
- $p_{sf}$  = Presión estática en mmca y Pa.
- SFP: Factor específico de potencia en  $W/m^3/s$  (curvas azules).
- Aire seco normal a  $20^\circ C$  y  $760$  mmHg.
- Ensayos realizados de acuerdo a Norma ISO 5801 y AMCA 210-99.

CAB-250 ECOWATT

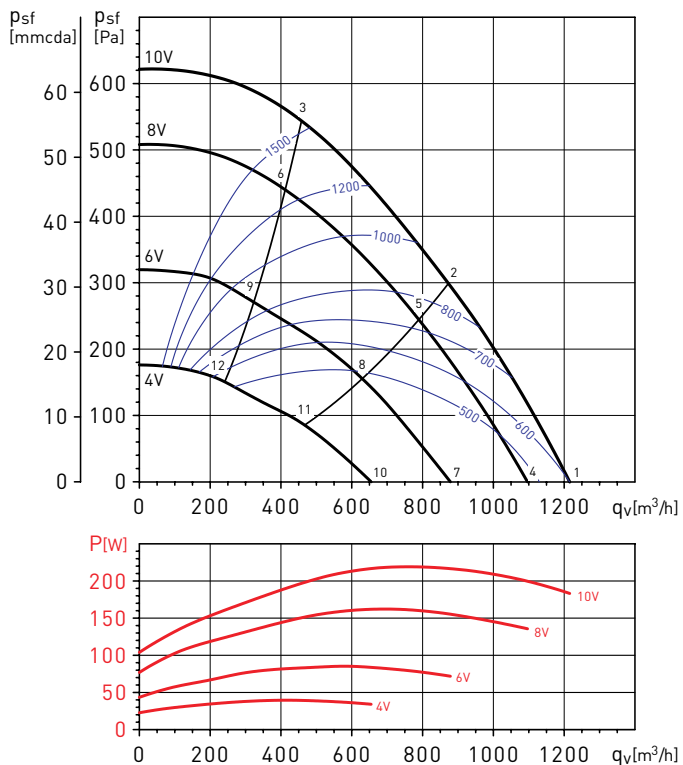

Espectros de potencia en dB(A)

Punto de trabajo		63	125	250	500	1.000	2.000	4.000	8.000	LwA
1	Aspiración	42	54	66	68	71	67	63	58	75
	Descarga	48	54	60	57	61	64	60	51	68
	Radiado	40	44	55	50	50	45	37	32	58
2	Aspiración	40	52	65	65	66	64	63	58	72
	Descarga	41	51	60	53	58	62	58	51	66
	Radiado	38	41	55	47	46	42	36	31	56
3	Aspiración	38	54	68	67	68	66	64	60	74
	Descarga	40	51	60	55	59	65	60	54	68
	Radiado	36	44	58	49	47	45	38	33	59
4	Aspiración	39	52	64	65	68	64	60	56	72
	Descarga	45	52	58	54	58	62	57	48	66
	Radiado	37	44	53	48	49	44	36	31	56
5	Aspiración	38	50	62	63	64	62	60	55	69
	Descarga	40	49	57	50	55	60	55	48	64
	Radiado	35	42	52	46	44	42	36	30	54
6	Aspiración	36	54	65	64	65	64	62	57	71
	Descarga	38	50	58	52	56	63	57	51	66
	Radiado	33	45	54	47	45	44	37	32	56
7	Aspiración	36	49	59	59	63	59	53	49	67
	Descarga	39	48	56	48	52	56	50	41	61
	Radiado	33	42	49	43	44	39	31	27	52
8	Aspiración	33	47	58	57	58	56	53	48	64
	Descarga	34	45	54	46	51	55	48	41	59
	Radiado	30	40	48	41	39	37	31	26	50
9	Aspiración	32	52	58	58	59	58	54	49	65
	Descarga	33	48	52	46	51	57	50	43	60
	Radiado	29	45	49	42	40	39	32	27	51
10	Aspiración	29	45	49	52	55	52	45	38	59
	Descarga	32	44	41	40	44	49	41	32	52
	Radiado	28	40	38	35	36	33	29	25	44
11	Aspiración	28	47	48	50	51	49	43	38	56
	Descarga	30	44	41	41	45	48	39	32	52
	Radiado	27	41	37	33	32	31	28	25	44
12	Aspiración	27	47	49	51	52	50	45	38	57
	Descarga	31	46	42	43	47	49	40	33	53
	Radiado	26	42	38	34	32	32	29	26	45

### CURVAS CARACTERÍSTICAS

- $q_v$  = Caudal en  $m^3/h$ .
- $p_{sf}$  = Presión estática en mmca y Pa.
- SFP: Factor específico de potencia en  $W/m^3/s$  (curvas azules).
- Aire seco normal a  $20^\circ C$  y  $760$  mmHg.
- Ensayos realizados de acuerdo a Norma ISO 5801 y AMCA 210-99.

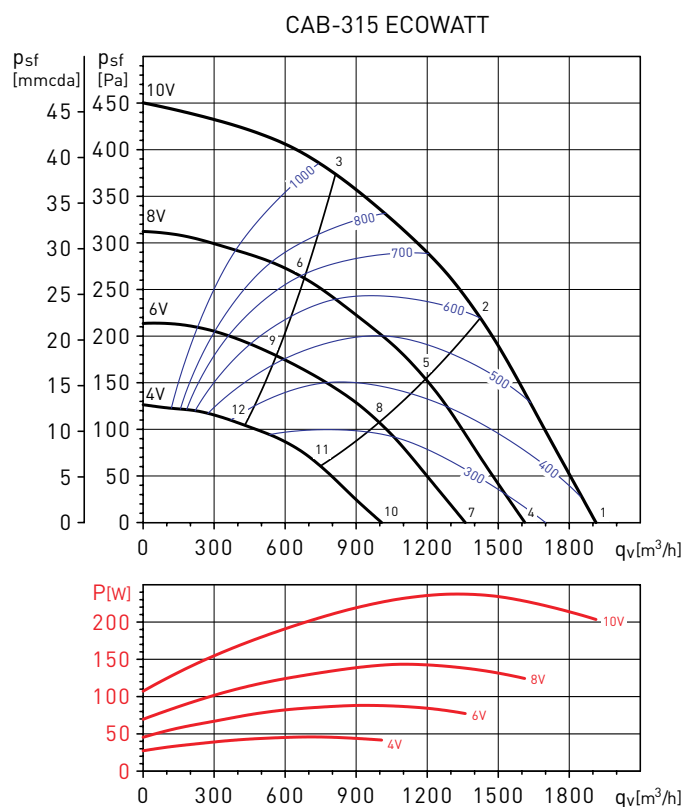

### Espectros de potencia en dB(A)

Punto de trabajo		63	125	250	500	1.000	2.000	4.000	8.000	LwA
1	Aspiración	41	54	67	67	66	63	59	57	72
	Descarga	47	57	66	59	64	60	53	46	69
	Radiado	42	48	65	54	57	54	49	46	66
2	Aspiración	41	54	67	66	64	59	56	53	71
	Descarga	43	55	65	56	62	58	51	44	68
	Radiado	42	48	65	53	55	50	46	42	66
3	Aspiración	41	58	67	66	64	58	55	51	71
	Descarga	41	53	63	56	62	60	56	48	68
	Radiado	42	52	65	53	54	49	45	40	66
4	Aspiración	39	53	62	63	63	58	53	54	68
	Descarga	43	55	62	55	59	56	48	42	65
	Radiado	40	46	59	49	53	53	43	41	61
5	Aspiración	40	54	64	61	59	53	49	49	67
	Descarga	41	53	61	52	58	53	45	38	64
	Radiado	40	47	61	47	50	48	39	36	62
6	Aspiración	38	58	62	61	59	54	49	45	67
	Descarga	39	51	58	52	58	56	51	40	63
	Radiado	38	51	59	47	50	49	39	31	60
7	Aspiración	39	54	57	59	59	53	49	50	64
	Descarga	41	56	52	50	57	51	43	40	61
	Radiado	39	50	50	45	51	44	38	36	56
8	Aspiración	37	55	54	57	55	48	45	40	62
	Descarga	38	54	49	47	55	48	40	36	59
	Radiado	37	51	47	43	48	39	34	26	54
9	Aspiración	35	57	54	57	55	49	44	39	62
	Descarga	35	52	48	47	56	50	42	35	59
	Radiado	35	52	47	43	48	40	33	25	55
10	Aspiración	35	48	50	55	52	43	46	31	58
	Descarga	37	49	46	46	49	43	40	30	54
	Radiado	37	45	44	43	48	37	36	24	52
11	Aspiración	32	46	48	54	48	41	37	29	56
	Descarga	34	46	42	47	47	41	34	30	52
	Radiado	33	42	41	42	45	34	27	22	49
12	Aspiración	33	48	49	55	49	41	36	30	58
	Descarga	33	45	42	46	47	42	31	29	52
	Radiado	34	44	42	43	46	35	26	23	50



### CURVAS CARACTERÍSTICAS

- $q_v$  = Caudal en  $m^3/h$ .
- $p_{sf}$  = Presión estática en mmcda y Pa.
- SFP: Factor específico de potencia en  $W/m^3/s$  (curvas azules).
- Aire seco normal a  $20^\circ C$  y  $760$  mmHg.
- Ensayos realizados de acuerdo a Norma ISO 5801 y AMCA 210-99.

CAB-355 ECOWATT

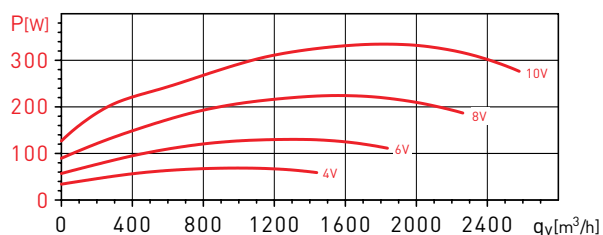
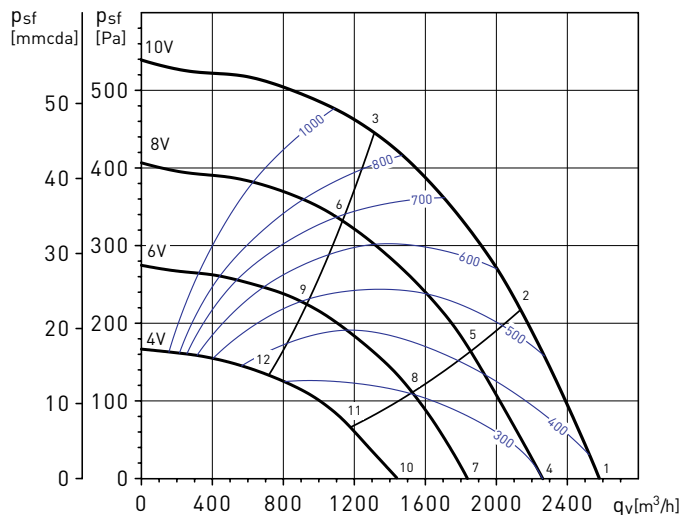

Espectros de potencia en dB(A)

Punto de trabajo	63	125	250	500	1.000	2.000	4.000	8.000	LwA	
1	Aspiración	46	58	67	67	67	66	64	63	74
	Descarga	52	59	63	62	66	62	55	49	70
	Radiado	41	49	62	53	55	53	48	49	64
2	Aspiración	42	55	67	66	66	63	60	59	72
	Descarga	45	55	63	59	63	60	52	46	68
	Radiado	37	46	61	52	54	51	45	45	63
3	Aspiración	39	58	65	64	63	60	58	55	70
	Descarga	41	55	61	56	61	58	51	46	66
	Radiado	34	48	60	50	51	47	42	41	61
4	Aspiración	41	58	64	64	65	63	58	61	71
	Descarga	48	56	62	58	63	59	51	46	67
	Radiado	36	49	59	49	53	51	42	48	61
5	Aspiración	37	55	64	62	63	58	55	56	69
	Descarga	41	53	63	54	61	56	48	42	66
	Radiado	32	46	59	47	51	46	38	42	60
6	Aspiración	37	61	61	60	58	52	52	48	67
	Descarga	38	53	61	51	59	54	47	41	64
	Radiado	32	52	56	45	46	40	36	35	58
7	Aspiración	37	58	57	60	65	58	54	57	68
	Descarga	42	58	52	52	63	53	46	42	65
	Radiado	34	50	47	44	50	45	38	44	56
8	Aspiración	33	58	55	58	60	51	50	50	64
	Descarga	37	56	49	49	63	51	42	37	64
	Radiado	30	51	45	42	45	38	34	37	53
9	Aspiración	34	56	53	56	57	48	47	42	62
	Descarga	35	54	47	46	63	49	41	34	63
	Radiado	29	50	44	40	49	35	31	29	53
10	Aspiración	32	51	52	55	56	49	52	38	61
	Descarga	36	52	46	47	52	47	43	30	57
	Radiado	30	43	42	46	45	37	39	30	51
11	Aspiración	29	49	50	52	50	43	46	33	57
	Descarga	33	49	43	45	51	44	38	26	54
	Radiado	27	41	40	43	39	31	33	25	47
12	Aspiración	28	47	47	50	47	40	39	33	54
	Descarga	31	45	41	42	50	41	33	26	52
	Radiado	26	39	37	41	36	28	26	25	45

### CURVAS CARACTERÍSTICAS

- $q_v$  = Caudal en  $m^3/h$ .
- $p_{sf}$  = Presión estática en mmcd y Pa.
- SFP: Factor específico de potencia en  $W/m^3/s$  (curvas azules).
- Aire seco normal a  $20^\circ C$  y  $760$  mmHg.
- Ensayos realizados de acuerdo a Norma ISO 5801 y AMCA 210-99.

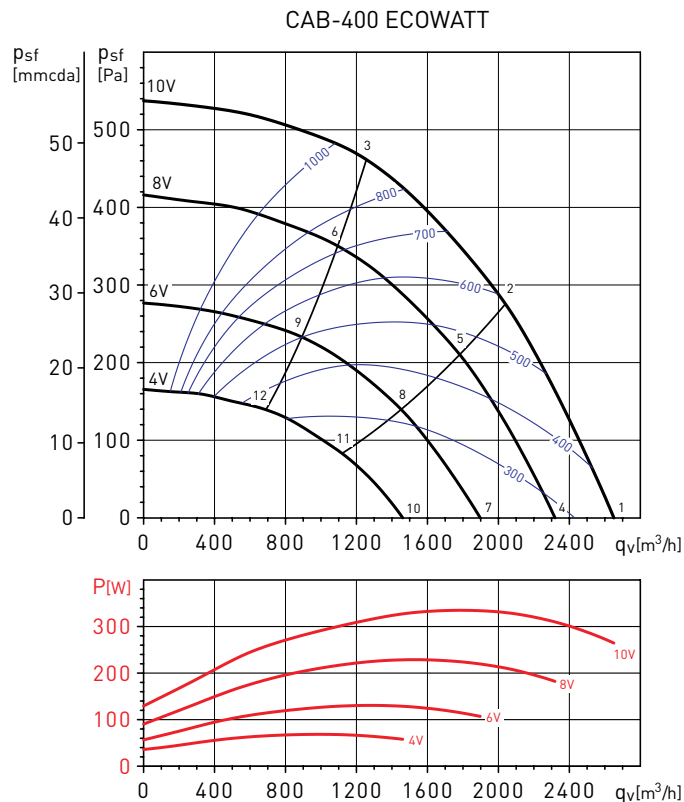

### Espectros de potencia en dB(A)

Punto de trabajo		63	125	250	500	1.000	2.000	4.000	8.000	LwA
1	Aspiración	46	58	65	67	65	66	61	57	72
	Descarga	46	59	64	63	67	63	56	49	71
	Radiado	44	50	62	56	58	58	51	47	65
2	Aspiración	40	54	63	64	62	60	53	51	69
	Descarga	41	54	63	59	64	60	52	46	68
	Radiado	38	46	60	53	55	52	44	41	62
3	Aspiración	41	58	64	63	58	54	51	47	68
	Descarga	41	57	61	58	62	58	53	47	67
	Radiado	39	50	61	52	51	46	41	38	62
4	Aspiración	39	53	62	63	63	58	53	54	68
	Descarga	43	55	62	55	59	56	48	42	65
	Radiado	40	46	59	49	53	53	43	41	61
5	Aspiración	40	54	64	61	59	53	49	49	67
	Descarga	41	53	61	52	58	53	45	38	64
	Radiado	40	47	61	47	50	48	39	36	62
6	Aspiración	38	58	62	61	59	54	49	45	67
	Descarga	39	51	58	52	58	56	51	40	63
	Radiado	38	51	59	47	50	49	39	31	60
7	Aspiración	39	54	57	59	59	53	49	50	64
	Descarga	41	56	52	50	57	51	43	40	61
	Radiado	39	50	50	45	51	44	38	36	56
8	Aspiración	37	55	54	57	55	48	45	40	62
	Descarga	38	54	49	47	55	48	40	36	59
	Radiado	37	51	47	43	48	39	34	26	54
9	Aspiración	35	57	54	57	55	49	44	39	62
	Descarga	35	52	48	47	56	50	42	35	59
	Radiado	35	52	47	43	48	40	33	25	55
10	Aspiración	35	48	50	55	52	43	46	31	58
	Descarga	37	49	46	46	49	43	40	30	54
	Radiado	37	45	44	43	48	37	36	24	52
11	Aspiración	32	46	48	54	48	41	37	29	56
	Descarga	34	46	42	47	47	41	34	30	52
	Radiado	33	42	41	42	45	34	27	22	49
12	Aspiración	33	48	49	55	49	41	36	30	58
	Descarga	33	45	42	46	47	42	31	29	52
	Radiado	34	44	42	43	46	35	26	23	50

ACCESORIOS DE MONTAJE



**MBE**  
Baterías eléctricas.



**MFL-G4**  
Cajas filtrantes.



**ACOPEL F400 N**  
Acoplamiento elástico circular.



**KSE-45**  
Soportes antivibratorios de goma que permiten amortiguar las vibraciones y atenuar el nivel sonoro de la instalación.  
(1KSE = 4 soportes en una bolsa)

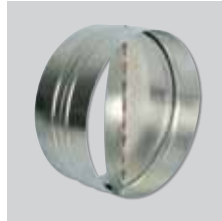

**CAR**  
Compuerta antirretorno.



**APC**  
Viseras aspiración-descarga.

ACCESORIOS ELÉCTRICOS



**CONTROL ECOWATT AC/DC**  
Elemento de control DCV (Demanda Controlada de Ventilación).



**CONTROL ECOWATT BASIC**  
Controlador de velocidades y paro/marcha.



**REB-ECOWATT**  
Regulador de velocidad.



**SC02-A**  
Sensor de CO<sub>2</sub> y temperatura.

**SC02-AD**  
Sensor de CO<sub>2</sub> y temperatura. Con display.

**SCHT-AD**  
Sensor de CO<sub>2</sub>, temperatura y humedad relativa. Con display.



**TDP-S / TDP-D**  
Transmisor de presión.



**CPFL-S / CPFL-E**  
Detectores de presencia.

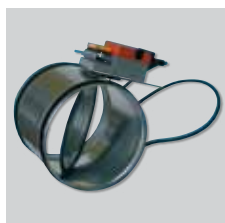

**REMP**  
Compuerta motorizada.