



Ventiladores helicoidales murales con hélice de plástico reforzada con fibra de vidrio, motor monofásico (HCFB) o trifásico (HCFT), IP65 (1), Clase F (2), protector térmico incorporado (3) y caja de bornes, con condensador incorporado en los modelos monofásicos.

(1) Modelos Ø 800, 900 y 1000: IP55.

(2) Temperatura de trabajo: de -40°C a +70°C, excepto los modelos 4-710 adecuados hasta +55°C y modelos Ø 800 a 1000 (de -20°C a 40°C).

(3) Excepto modelos Ø 800 a 1000.

Motores

De 2, 4 ó 6 polos, según versiones. Regulables por tensión con autotransformador, excepto modelos de 2 polos y /4-630, 710, T/800, T/900 y T/1.000. Modelos trifásicos regulables por convertidor de frecuencia.

Tensión de alimentación

Monofásicos 230V-50Hz

Trifásicos 230/400V-50Hz ó 400V-50Hz

(Ver cuadro de características).

Otros datos

Sentido del aire Motor-Hélice (flujo A). Modelos Ø 800 a 1000 con defensa de aspiración, bajo demanda.



Gran compacidad

Especial diseño del conjunto motor-hélice, que proporciona gran compacidad y hermeticidad IP65.



Resistencia a la corrosión

Conjunto metálico marco-rejilla protegido contra la corrosión mediante tratamiento por cataforesis + pintura poliéster. Tornillería inoxidable.



Caja de bornes con condensador

Caja de bornes (contiene el condensador en los modelos monofásicos). Prensaestopas PG-11.



PROTECCIÓN

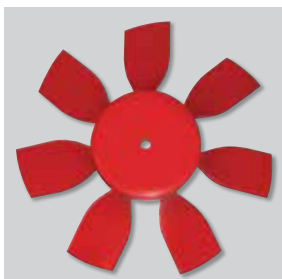

Hélice equilibrada dinámicamente

Hélice equilibrada dinámicamente, según norma ISO 1940, para reducir el ruido y evitar vibraciones.



Variantes de fabricación

Múltiples variantes de fabricación, en función del tipo de instalación y de las condiciones de utilización.



Configuración constructiva Modelos Ø 800 a 1.000

Especial diseño del conjunto motor-hélice, que proporciona gran compacidad y hermeticidad IP55.



Ventiladores helicoidales murales con hélice de aluminio y motor monofásico (HCBB) o trifásico (HCBT), IP65 (1), Clase F (2), protector térmico incorporado (3) y caja de bornes, con condensador incorporado en los modelos monofásicos.

- (1) Modelos Ø 800, 900 y 1000: IP55.
(2) Temperatura de trabajo: de -40°C a +70°C, excepto los modelos 4-710 adecuados hasta +55°C y modelos Ø 800, 900 y 1000 de -20°C hasta +40°C.
(3) Excepto modelos Ø 800 a 1000.

Motores

De 4 ó 6 polos, según versiones.
Regulables por tensión con autotransformador, excepto modelos 4-630, B/710, T/4-710, T/800, T/900 y T/1000.

Modelos trifásicos regulables por convertidor de frecuencia.

Tensión de alimentación

Monofásicos 230V-50Hz
Trifásicos 230/400V-50Hz ó 400V-50Hz
(Ver cuadro de características).

Otros datos

Sentido del aire Motor-Hélice (flujo A).
Modelos Ø 800 a 1000 con defensa de aspiración, bajo demanda.

Versiones ATEX

Bajo pedido, versiones antiexplosivas según la Directiva ATEX para modelos trifásicos:

- Motores IP55, Clase F.
- ATEX Antideflagrantes - Gas
Para modelos del 800 al 1000:
⊕ II 2G Ex d IIB T4
⊕ II 2G Ex d IIB+H2 T4 (con motor Ex d IIC T4)
- ATEX Seguridad aumentada - Gas
Excepto modelos HCBT/ 4-250, HCBT/ 6-355, HCBT/ 6-400.
Sí disponible HCBT/ 6-400 con motor 230/400V.
Sí disponible para modelos hasta HCBT-1000
⊕ II 2G Ex e II T3.
- ATEX - Polvo
Para modelos 800 a 1000 mm.
Partículas en suspensión inflamables y polvo no conductor:
⊕ II 3D Ex tc IIIB T125°C
Polvo conductor:
⊕ II 3D Ex tc IIIC T125°C (con motor IP65)

Para trabajar a temperaturas de:

- 20°C a +55°C:
modelos HCBT/4-315 a HCBT/4-710
modelos HCBT/6-450 a HCBT 6-710
- 20°C a +40°C:
modelo HCBT/4-800 a 1000
modelo HCBT/6-800 a 1000

Para seleccionar modelos HCBT ATEX, ver el programa de selección de producto EASYVENT. Los datos eléctricos de los modelos ATEX pueden variar respecto a los datos indicados en las tablas características. Consulte la disponibilidad de otras versiones de motores ATEX.



PROTECCIÓN

Aplicaciones específicas



Versiones



Gran compacidad

Especial diseño del conjunto motor-hélice, que proporciona gran compacidad y hermeticidad IP65.

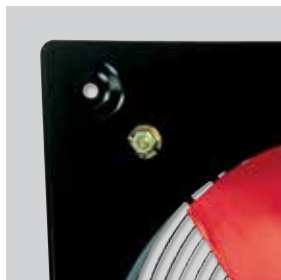

Resistencia a la corrosión

Conjunto metálico marco-rejilla protegido contra la corrosión mediante tratamiento por cataforesis + pintura poliéster.
Tornillería inoxidable.



Caja de bornes con condensador

Caja de bornes (contiene el condensador en los modelos monofásicos). Prensaestopas PG-11.

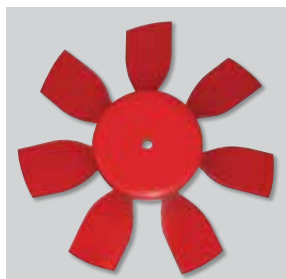

Hélice equilibrada dinámicamente

Hélice equilibrada dinámicamente, según norma ISO 1940, para reducir el ruido y evitar vibraciones.



Variantes de fabricación

Múltiples variantes de fabricación, en función del tipo de instalación y de las condiciones de utilización.



Configuración constructiva Modelos Ø 800 a 1.000

Especial diseño del conjunto motor-hélice, que proporciona gran compacidad y hermeticidad IP55.

CARACTERÍSTICAS TÉCNICAS PARA MODELOS CON HÉLICE DE PLÁSTICO

Es imprescindible comprobar que las características eléctricas (voltaje, intensidad, frecuencia, etc.) del motor que aparecen en la placa del mismo son compatibles con las de la instalación.

Modelo	Velocidad (r.p.m.)	Ø Boca (mm)	Potencia absorbida máxima (W)	Intensidad máxima (A)		Nivel de presión sonora* (dB(A))	Caudal máximo (m³/h)	Peso (kg)	Regulador de tensión opcional		Convertidor de frecuencia opcional	
				230 V	400 V				REB	RMB/T**	VFTM**	VFKB**
MONOFASICOS 2 POLOS												
HCGB/2-315/I	2690	315	336	1,5	-	63	3.150	7	-	-	-	-
HCGB/2-355/I	2730	355	392	1,7	-	68	3.550	8	-	-	-	-
MONOFASICOS 4 POLOS												
HCFB/4-250/H	1380	250	77	0,3	-	49	1.090	5	REB-1	RMB-1,5	-	-
HCFB/4-315/H	1340	315	125	0,6	-	55	2.220	7	REB-1	RMB-1,5	-	-
HCFB/4-355/H	1415	355	168	0,7	-	59	3.470	8	REB-2,5	RMB-1,5	-	-
HCFB/4-400/H	1420	400	271	1,2	-	62	4.920	9	REB-2,5	RMB-3,5	-	-
HCFB/4-450/H	1380	450	471	2,0	-	65	6.830	13	REB-2,5	RMB-3,5	-	-
HCFB/4-500/H	1400	500	671	2,9	-	68	9.140	16	REB-5	RMB-3,5	-	-
HCFB/4-560/H	1410	560	1102	4,7	-	70	12.980	22	REB-5	RMB-8	-	-
HCFB/4-630/H	1380	630	1573	7,1	-	73	17.230	25	-	-	-	-
MONOFASICOS 6 POLOS												
HCFB/6-315/H	990	315	80	0,4	-	45	1.620	7	REB-1	RMB-1,5	-	-
HCFB/6-355/H	920	355	81	0,4	-	48	2.250	8	REB-1	RMB-1,5	-	-
HCFB/6-400/H	885	400	100	0,4	-	51	2.980	9	REB-1	RMB-1,5	-	-
HCFB/6-450/H	920	450	103	0,7	-	54	3.510	13	REB-2,5	RMB-1,5	-	-
HCFB/6-500/H	920	500	224	1,0	-	57	6.030	16	REB-2,5	RMB-3,5	-	-
HCFB/6-560/H	905	560	321	1,3	-	59	8.180	22	REB-2,5	RMB-3,5	-	-
HCFB/6-630/H	915	630	469	2,0	-	62	11.000	25	REB-5	RMB-3,5	-	-
TRIFASICOS 2 POLOS												
HCGT/2-315/L	2630	315	461	2,4	1,4	68	3.790	7	-	-	VFTM-Tri 0,37	VFKB-45
HCGT/2-355/I	2570	355	497	2,4	1,4	71	4.490	8	-	-	VFTM-Tri 0,37	VFKB-45
TRIFASICOS 4 POLOS												
HCFT/4-250/H	1365	250	73	0,3	0,2	49	1.110	5	-	RMT-1,5	VFTM-Tri 0,37	VFKB-45
HCFT/4-315/H	1340	315	124	0,5	0,3	55	2.170	7	-	RMT-1,5	VFTM-Tri 0,37	VFKB-45
HCFT/4-355/H	1385	355	171	0,9	0,5	59	3.550	8	-	RMT-1,5	VFTM-Tri 0,37	VFKB-45
HCFT/4-400/H	1370	400	250	1,0	0,6	62	4.790	9	-	RMT-1,5	VFTM-Tri 0,37	VFKB-45
HCFT/4-450/H	1380	450	449	1,4	0,8	65	6.640	13	-	RMT-1,5	VFTM-Tri 0,37	VFKB-45
HCFT/4-500/H	1460	500	767	3,5	2,0	68	9.750	16	-	RMT-2,5	VFTM-Tri 0,75	VFKB-45
HCFT/4-560/H	1390	560	1051	3,8	2,2	70	12.500	22	-	RMT-2,5	VFTM-Tri 0,75	VFKB-45
HCFT/4-630/H	1425	630	1582	5,0	2,9	73	17.900	25	-	-	VFTM-Tri 1,1	VFKB-45
HCFT/4-710/H	1375	710	2413	7,4	4,3	74	22.140	27	-	-	VFTM-Tri 1,5	VFKB-45
HCFT/4-800/L-X-1,5	1420	800	2308	6,6	3,8	78	22.780	37	-	-	VFTM-Tri 1,5	VFKB-45
HCFT/4-800/H-X-3	1450	800	4344	12,5	7,2	84	33.410	52	-	-	VFTM-Tri 4	VFKB-48
HCFT/4-900/L-X-3	1460	900	3845	11,3	6,5	82	25.550	61	-	-	VFTM-Tri 3	VFKB-48
HCFT/4-900/H-X-5,5	1460	900	7090	12,3	8,7	87	45.550	95	-	-	VFTM-Tri 5,5	-
HCFT/4-1000/L-X-3	1440	1000	5098	14,2	8,2	86	38.800	67	-	-	VFTM-Tri 3	VFKB-48
HCFT/4-1000/H-X-7,5	1470	1000	8228	13,7	9,3	93	47.370	100	-	-	VFTM-Tri 7,5	-
TRIFASICOS 6 POLOS												
HCFT/6-315/H		315										
HCFT/6-355/H	925	355	83	0,3	0,2	48	2.260	8	-	RMT-1,5	VFTM-Tri 0,37	VFKB-45
HCFT/6-400/H	880	400	107	0,5	0,3	51	3.070	9	-	RMT-1,5	VFTM-Tri 0,37	VFKB-45
HCFT/6-450/H	910	450	146	0,5	0,3	54	4.440	13	-	RMT-1,5	VFTM-Tri 0,37	VFKB-45
HCFT/6-500/H	920	500	240	1,0	0,6	57	6.350	16	-	RMT-1,5	VFTM-Tri 0,37	VFKB-45
HCFT/6-560/H	925	560	337	1,2	0,7	59	8.320	22	-	RMT-1,5	VFTM-Tri 0,37	VFKB-45
HCFT/6-630/H	920	630	534	2,1	1,2	62	11.400	25	-	RMT-1,5	VFTM-Tri 0,37	VFKB-45
HCFT/6-710/H	955	710	888	4,5	2,6	65	16.260	27	-	RMT-5	VFTM-Tri 1,5	VFKB-45
HCFT/6-800/L-X-0,55	940	800	1042	3,5	2,0	73	18.310	31	-	-	VFTM-Tri 0,75	VFKB 45
HCFT/6-800/H-X-0,75	945	800	1160	3,8	2,2	75	19.960	36	-	-	VFTM-Tri 1,1	VFKB 45
HCFT/6-900/L-X-1,1	965	900	1266	4,7	2,7	74	23.160	53	-	-	VFTM-Tri 1,5	VFKB 45
HCFT/6-900/H-X-1,5	955	900	2202	7,1	4,1	78	31.720	56	-	-	VFTM-Tri 1,5	VFKB 45
HCFT/6-1000/L-X-1,1	940	1000	1749	5,7	3,3	79	28.970	54	-	-	VFTM-Tri 1,5	VFKB 45
HCFT/6-1000/H-X-1,5	945	1000	2627	8,1	4,7	84	37.980	59	-	-	VFTM-Tri 2,2	VFKB 45

* Nivel de presión sonora, medida en campo libre, a una distancia equivalente a tres veces el diámetro de la hélice, con un mínimo de 1,5 metros.

** Alimentación de los reguladores trifásicos (RMT) o convertidores de frecuencia (VFKB/VFTM): trifásicos 400V.

CARACTERÍSTICAS TÉCNICAS PARA MODELOS CON HÉLICE DE ALUMINIO

Es imprescindible comprobar que las características eléctricas (voltaje, intensidad, frecuencia, etc.) del motor que aparecen en la placa del mismo son compatibles con las de la instalación.

Modelo	Velocidad (r.p.m.)	Ø Boca (mm)	Potencia absorbida máxima (W)	Intensidad máxima (A)		Nivel de presión sonora* (dB(A))	Caudal máximo (m³/h)	Peso (kg)	Regulador de tensión opcional		Convertidor de frecuencia opcional	
				230 V	400 V				REB	RMB/T**	VFTM**	VFKB**
MONOFASICOS 4 POLOS												
HCBB/4-250/H	1325	250	84	0,4	-	49	1.130	5	REB-1	RMB-1,5	-	-
HCBB/4-315/H	1235	315	124	0,7	-	55	2.220	7	REB-1	RMB-1,5	-	-
HCBB/4-355/H	1385	355	193	0,9	-	59	3.590	8	REB-2,5	RMB-1,5	-	-
HCBB/4-400/H	1360	400	315	1,5	-	62	4.830	9	REB-2,5	RMB-3,5	-	-
HCBB/4-450/H	1410	450	626	2,8	-	65	7.180	13	REB-5	RMB-3,5	-	-
HCBB/4-500/H	1370	500	762	3,3	-	68	8.850	16	REB-5	RMB-3,5	-	-
HCBB/4-560/H	1390	560	1433	6,5	-	70	13.400	22	REB-10	RMB-8	-	-
HCBB/4-630/H	1360	630	1879	8,3	-	71	16.720	25	-	-	-	-
MONOFASICOS 6 POLOS												
HCBB/6-355/H	900	355	84	0,4	-	48	2.230	8	REB-1	RMB-1,5	-	-
HCBB/6-400/H	845	400	112	0,5	-	51	3.010	9	REB-1	RMB-1,5	-	-
HCBB/6-450/H	935	450	191	0,8	-	54	4.400	13	REB-2,5	RMB-1,5	-	-
HCBB/6-500/H	915	500	244	1,1	-	57	5.620	16	REB-2,5	RMB-3,5	-	-
HCBB/6-560/H	930	560	449	1,9	-	59	8.950	22	REB-2,5	RMB-3,5	-	-
HCBB/6-630/H	915	630	588	2,9	-	62	10.950	25	REB-5	RMB-3,5	-	-
TRIFASICOS 4 POLOS												
HCBT/4-250/H	1330	250	81	0,3	0,2	49	1.120	5	-	RMT-1,5	VFTM-Tri 0,37	VFKB-45
HCBT/4-315/H	1330	315	125	0,5	0,3	55	2.380	7	-	RMT-1,5	VFTM-Tri 0,37	VFKB-45
HCBT/4-355/H	1380	355	181	0,8	0,5	59	3.530	8	-	RMT-1,5	VFTM-Tri 0,37	VFKB-45
HCBT/4-400/H	1340	400	283	1,2	0,7	62	5.020	9	-	RMT-1,5	VFTM-Tri 0,37	VFKB-45
HCBT/4-450/H	1350	450	547	1,7	1,0	65	6.800	13	-	RMT-1,5	VFTM-Tri 0,37	VFKB-45
HCBT/4-500/H	1390	500	809	2,7	1,6	68	9.140	16	-	RMT-2,5	VFTM-Tri 0,55	VFKB-45
HCBT/4-560/H	1390	560	1287	4,0	2,3	70	12.950	22	-	RMT-2,5	VFTM-Tri 0,75	VFKB-45
HCBT/4-630/H	1385	630	1736	5,4	3,1	73	16.840	25	-	-	VFTM-Tri 1,1	VFKB-45
HCBT/4-710/H	1350	710	2554	7,6	4,4	74	22.400	27	-	-	VFTM-Tri 2,2	VFKB-45
HCBT/4-800/L-X-1,5	1410	800	2632	7,3	4,2	78	23.290	37	-	-	VFTM-Tri 1,5	VFKB-45
HCBT/4-800/H-X-3	1440	800	4595	12,8	7,4	84	33.100	52	-	-	VFTM-Tri 4	VFKB-48
HCBT/4-900/L-X-3	1450	900	3909	12,0	6,9	82	34.270	62	-	-	VFTM-Tri 3	VFKB-48
HCBT/4-900/H-X-5,5	1455	900	7893	-	13,4	87	46.270	96	-	-	VFTM-Tri 5,5	-
HCBT/4-1000/L-X-3	1415	1000	5048	14,2	8,2	86	39.910	67	-	-	VFTM-Tri 4	VFKB-48
HCBT/4-1000/H-X-7,5	1470	1000	8675	-	14,6	93	53.700	101	-	-	VFTM-Tri 7,5	-
TRIFASICOS 6 POLOS												
HCBT/6-355/H	900	355	91	0,3	0,2	48	2.270	8	-	RMT-1,5	VFTM-Tri 0,37	VFKB-45
HCBT/6-400/H	840	400	120	0,5	0,3	51	3.050	9	-	RMT-1,5	VFTM-Tri 0,37	VFKB-45
HCBT/6-450/H	925	450	198	0,9	0,5	54	4.620	13	-	RMT-1,5	VFTM-Tri 0,37	VFKB-45
HCBT/6-500/H	905	500	282	1,1	0,6	57	6.190	16	-	RMT-1,5	VFTM-Tri 0,37	VFKB-45
HCBT/6-560/H	895	560	401	1,4	0,8	59	8.650	22	-	RMT-1,5	VFTM-Tri 0,37	VFKB-45
HCBT/6-630/H	910	630	596	2,3	1,3	62	10.950	25	-	RMT-1,5	VFTM-Tri 0,37	VFKB-45
HCBT/6-710/H	950	710	953	4,7	2,7	65	15.350	27	-	RMT-5	VFTM-Tri 1,5	VFKB-45
HCBT/6-800/L-X-0,55	940	800	1025	3,3	1,9	73	17.600	31	-	-	VFTM-Tri 0,75	VFKB-45
HCBT/6-800/H-X-0,75	935	800	1309	4,2	2,4	75	20.630	36	-	-	VFTM-Tri 1,1	VFKB-45
HCBT/6-900/L-X-1,1	960	900	1341	4,8	2,8	74	23.700	54	-	-	VFTM-Tri 1,5	VFKB-45
HCBT/6-900/H-X-1,5	955	900	2289	7,3	4,2	78	32.300	57	-	-	VFTM-Tri 1,5	VFKB-45
HCBT/6-1000/L-X-1,1	940	1000	1855	5,9	3,4	79	28.810	56	-	-	VFTM-Tri 1,5	VFKB-45
HCBT/6-1000/H-X-1,5	940	1000	2392	7,7	4,4	83	34.300	60	-	-	VFTM-Tri 2,2	VFKB-45

* Nivel de presión sonora, medida en campo libre, a una distancia equivalente a tres veces el diámetro de la hélice, con un mínimo de 1,5 metros.

** Alimentación de los reguladores trifásicos (RMT) o convertidores de frecuencia (VFKB/VFTM): trifásicos 400V.

REFERENCIA

H	C	F	T	/	4	-	4	0	0	/	H	A							
1	2	3	4		5		6				7	8							9

- | | | |
|---|---|--|
| <p>1 - H: Helicoidal mural.</p> <p>2 - C: Sigla de la serie.</p> <p>3 - Tipo de hélice:</p> <p>F: Ø 250 - Ø 630 Hélice de plástico de álabes fijos.</p> <p>Ø 710 - Ø 1000 Hélice de cubo de aluminio + álabes de plástico orientables.</p> <p>G: Hélice de plástico de álabes orientables.</p> <p>B: Ø 250-Ø 400 Hélice aluminio de álabes fijos Ø 450 - Ø 1000 Hélice de aluminio de álabes orientables.</p> | <p>4 - Tipo de alimentación:</p> <p>B: Monofásico</p> <p>T: Trifásico</p> <p>5 - Número de polos:</p> <p>2: (aprox. 2900 r.p.m. - 50Hz)</p> <p>4: (aprox. 1400 r.p.m. - 50Hz)</p> <p>6: (aprox. 900 r.p.m. - 50Hz)</p> <p>6 - Diámetro nominal del ventilador en mm.</p> <p>7 - Ángulo de inclinación de los álabes.</p> <p>H: Grande</p> <p>I, L: Pequeño</p> <p>8 - Sentido del aire:</p> <p>A: Motor-Hélice</p> | <p>9 - Variantes de fabricación:</p> <p>W: Con caja de bornes remota.</p> <p>M: Sin caja de bornes.</p> <p>X: Soporte sin rejilla.</p> <p>P: Soporte profundo.</p> <p>N: Sin marco embocadura.</p> <p>S: Conjunto motor-hélice.</p> <p>L: Funcionamiento bajo lluvia.</p> <p>C: Eliminación de condensaciones.</p> <p>EX: Versiones antiexplosivas y antideflagrantes.</p> <p>G: Anticorrosión reforzada para aplicaciones en granjas.</p> <p>TF: Con pintura anticorrosiva de teflón.</p> |
|---|---|--|

CONEXIÓN ELÉCTRICA



Tipo de red eléctrica	Tipo de motor	Conexión	Velocidad
MONOFÁSICA 220V 50Hz, 240V 50Hz	230V 50Hz	Según esquema del aparato	Rápida
TRIFÁSICA 220V 50Hz 240V 50Hz	230/400V 50Hz		Rápida
			Lenta*
TRIFÁSICA 380V 50Hz 415V 50Hz	230/400V 50Hz		Rápida
			Rápida
	400V 50Hz		Lenta*

* Para los modelos que admiten regulación en tensión mediante RMT

CARACTERÍSTICAS ACÚSTICAS

El nivel sonoro indicado en los cuadros de características técnicas y en las curvas características, corresponde a un valor de presión en dB(A), medido en campo libre a una distancia equivalente a tres veces el diámetro de la hélice con un mínimo de 1,5 metros.

Espectro de potencia sonora en dB(A) por banda de frecuencia en Hz y en el punto de máximo caudal.

Modelo	63	125	250	500	1000	2000	4000	8000	LwA
HCGB/2-315	50	61	68	70	72	69	64	58	77
HCGT/2-315	55	66	73	75	77	74	69	63	82
HCGB/2-355	55	66	73	75	77	74	69	63	82
HCGT/2-355	55	70	69	77	82	78	73	66	85

Modelo	63	125	250	500	1000	2000	4000	8000	LwA
/4-250/H	31	45	52	57	58	57	52	44	63
/4-315/H	42	53	60	62	64	61	56	50	69
/4-355/H	43	58	57	65	70	66	61	54	73
/4-400/H	48	61	62	68	73	69	66	57	76
/4-450/H	46	65	62	68	75	74	69	62	79
/4-500/H	49	68	68	74	78	76	72	65	82
/4-560/H	57	70	74	78	80	78	74	67	85
/4-630/H	57	72	76	81	85	82	79	72	89
/4-710/H	58	75	83	85	87	85	81	72	92
/4-800/L	58	77	87	93	93	89	83	76	97
/4-800/H	64	83	93	99	99	95	89	82	103
/4-900/L	59	81	91	97	98	94	88	80	102
/4-900/H	64	86	96	102	103	99	93	85	107
/4-1000/L	62	85	95	101	102	98	93	84	106
/4-1000/H	69	92	102	107	109	105	100	90	113

Modelo	63	125	250	500	1000	2000	4000	8000	LwA
/6-315/H	32	43	50	52	54	51	46	40	59
/6-355/H	32	47	46	54	59	55	50	43	62
/6-400/H	37	50	51	57	62	58	55	46	65
/6-450/H	35	54	51	57	64	63	58	51	68
/6-500/H	38	57	57	63	67	65	61	54	71
/6-560/H	46	59	63	67	69	67	63	56	74
/6-630/H	46	61	65	70	74	71	68	61	78
/6-710/H	49	66	74	76	78	76	72	63	83
/6-800/L	52	71	81	87	87	83	77	70	91
/6-800/H	54	73	83	89	89	85	79	72	93
/6-900/L	51	73	83	89	90	86	80	72	94
/6-900/H	55	77	87	93	94	90	84	76	98
/6-1000/L	56	78	89	94	96	92	86	77	100
/6-1000/H	60	83	93	99	100	96	91	82	104

DIMENSIONES (mm)

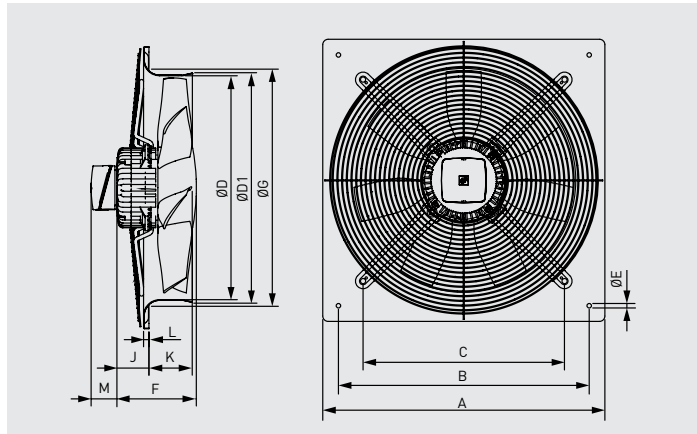

Modelo	A	B	C	Ø D	Ø D1	Ø E	F			Ø G	J			K	L	M	
							Número de polos				Número de polos					Tri	Mono
							/2	/4	/6		/2	/4	/6				
250	315	260	220	254	261	10				294			53	12	58	65	
315	400	330	280	315	320	10	129	122	122	329	45	32	32	68	12	58	65
355	450	380	315	355	363	10	129	129	129	371	45	45	45	75	12	58	65
400	500	420	355	400	410	10		129	129	422		40,5	40,5	78	12	58	65
450	560	480	400	450	457	10		150	150	476		48	48	91	12	58	65
500	630	560	450	500	512	10		217	150	536		112	44,5	97	12	58	65
560	710	630	510	560	570	10		218,5	150	596		110,5	42	98,5	12	58	65
630	800	710	580	630	640	12		218,5	150	674		110,5	41	103	12	58	65
710	900	800	636	710	720	12		220	218,5	733		114	134	91,5	16,5	58	65

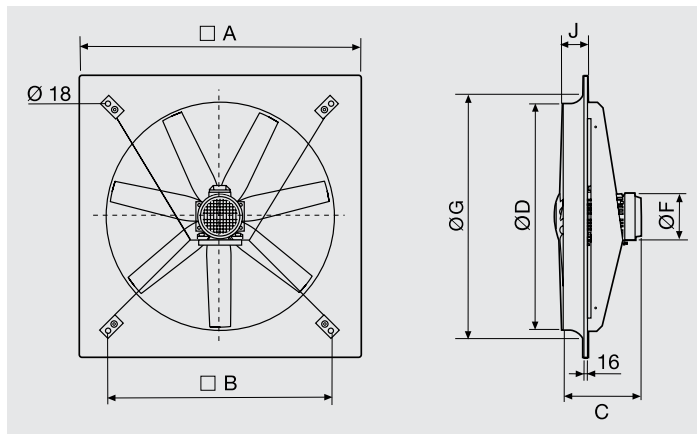

Modelo	A	B	Ø D	J	Ø G	C				Ø F			
						/4		/6		/4		/6	
						L	H	L	H	L	H	L	H
800	1000	800	800	92	926	345	380	310	345	181	203	162	181
900	1120	900	900	120	1060	392	439	350	392	203	280	181	203
1000	1250	1000	1000	110	1154	380	485	345	380	203	280	181	203

ACCESORIOS DE MONTAJE

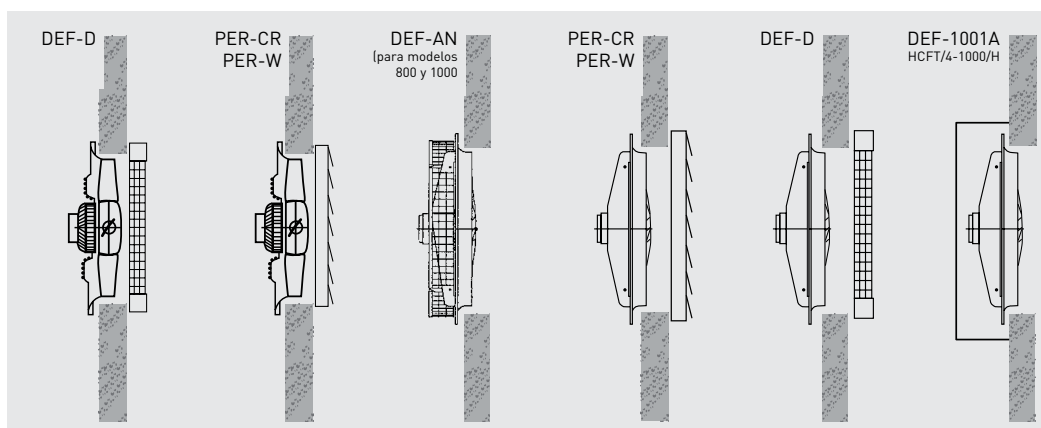
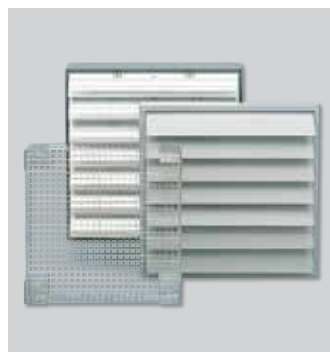

Modelo HCFB/HCFT HCBB/HCBT	Defensas de protección		Persianas de sobrepresión	
	Descarga	Aspiración	Plástico	Aluminio
250	DEF-250 D	-	PER-250 W	PER-250 CR
315	DEF-325 D	-	PER-355 W	PER-355 CR
355	DEF-375 D	-	PER-355 W	PER-355 CR
400	DEF-450 D	-	PER-400 W	PER-400 CR
450	DEF-450 D	-	PER-450 W	PER-450 CR
500	DEF-525 D	-	PER-500 W	PER-500 CR
560	DEF-630 D	-	PER-560 W	PER-630 CR
630	DEF-630 D	-	PER-630 W	PER-630 CR
710	DEF-800 D	-	PER-710 W	PER-710 CR
800	DEF-800 D	DEF- 800 AN	PER-800 W	PER-800 CR
/4-900/H	DEF-1000 D	DEF- 900 AN	PER-1000 W	PER-1000 CR
/4-900/L	DEF-1000 D	DEF- 901 AN	PER-1000 W	PER-1000 CR
/6-900	DEF-1000 D	DEF- 901 AN	PER-1000 W	PER-1000 CR
1000	DEF-1000 D	DEF-1000 AN	PER-1000 W	PER-1000 CR
/4-1000/H	DEF-1000 D	DEF-1001 AN	PER-1000 W	PER-1000 CR

ACCESORIOS ELÉCTRICOS



REB-1N / REB-2,5N

Reguladores electrónicos monofásicos.



REB-5

Reguladores electrónicos monofásicos.



RMB/RMT

Reguladores electromecánicos monofásicos y trifásicos.



REB-4 Auto

Regulador electrónico monofásico. Específico para granjas.



VFTM TRI IP54

Convertidores de frecuencia para motores de 0,37 a 15 kW - 230V ó 400V.



VFKB IP65

Convertidores de frecuencia para motores de 0,37 a 4 kW - 230V ó 400V.



COM D/S

Conmutador estrella / triángulo, para el arranque de los ventiladores trifásicos dotados de motor 400V.

CURVAS CARACTERÍSTICAS - MOTORES DE 2 POLOS

- q_v = Caudal en m^3/h y m^3/s
- p_{sf} = Presión estática en mmcdal y Pa
- p_g : Pérdida de carga de la defensa en Pa
- SFP: Factor específico de potencia en $W/m^3/s$
- P: Potencia absorbida en W
- Categoría de medición: A
- Categoría de eficiencia: estática.
- Eficiencia del ventilador sin mando de regulación de velocidad.
- Pruebas efectuadas con el ventilador sin defensa.
- Caudal de acuerdo a la Norma ISO 5801.
- Nivel de presión sonora en dB(A), medido en campo libre a una distancia equivalente a 3 veces el diámetro, con un mínimo de 1,5 m.

- MC** Categoría de medición
- EC** Categoría de eficiencia
- VSD** Mando de regulación de velocidad: debe suministrarse con el ventilador
- SR** Relación específica
- η [%]** Eficiencia
- N** Grado de eficiencia
- [kW]** Potencia absorbida
- [m^3/h]** Caudal
- [Pa]** Presión estática
- [RPM]** Velocidad

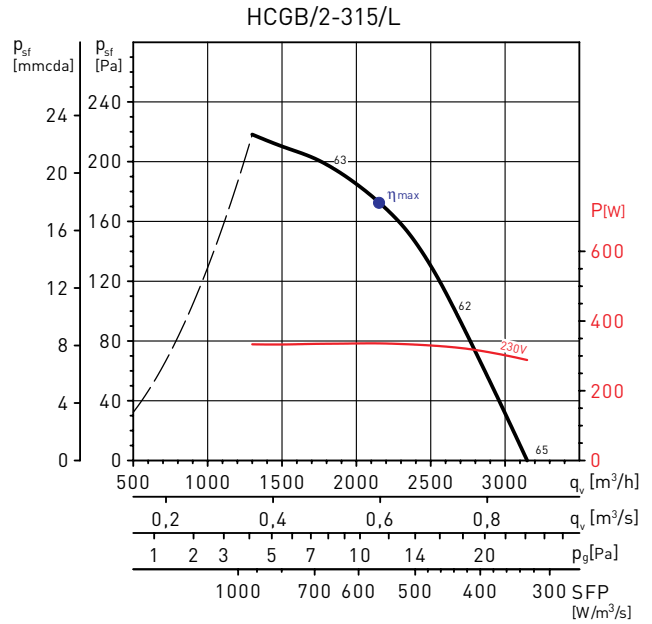

MC	EC	VSD	SR	η [%]	N	[kW]	[m^3/h]	[Pa]	[RPM]
A	Static	No	1	30,8	40,1	0,336	2106	177	2597

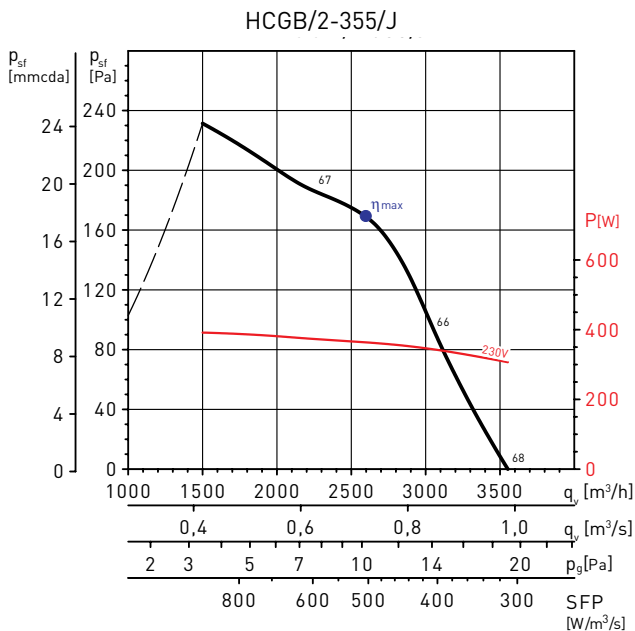

MC	EC	VSD	SR	η [%]	N	[kW]	[m^3/h]	[Pa]	[RPM]
A	Static	No	1	33,8	42,9	0,364	2597	169	2590

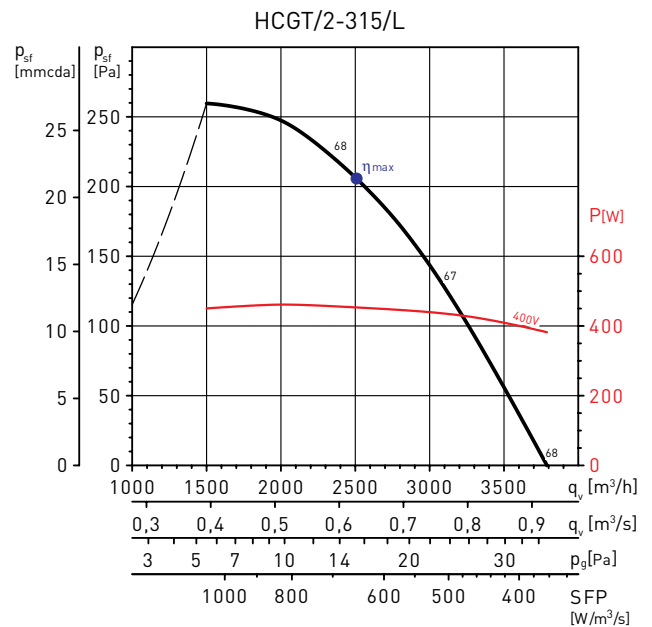

MC	EC	VSD	SR	η [%]	N	[kW]	[m^3/h]	[Pa]	[RPM]
A	Static	No	1	31,7	40,2	0,455	2440	212	2543

CURVAS CARACTERÍSTICAS - MOTORES DE 2 y 4 POLOS

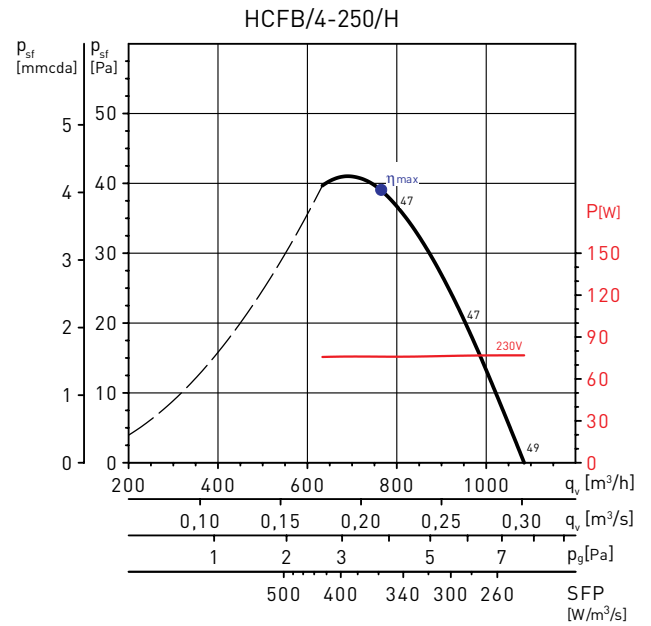
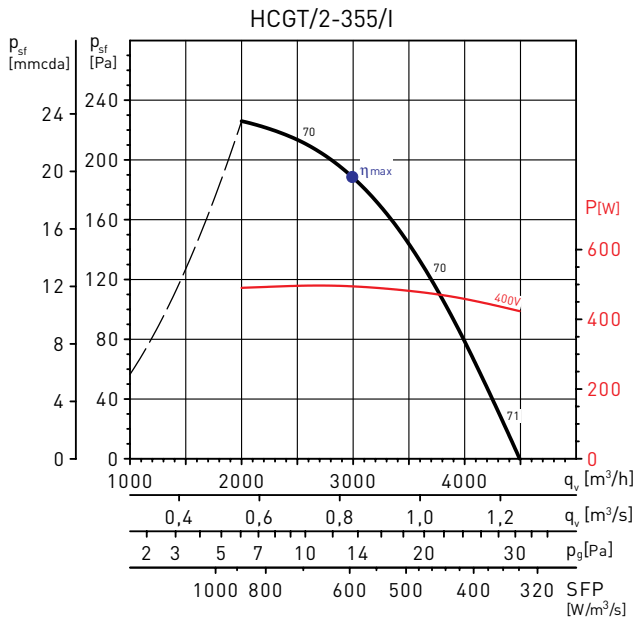

MC	EC	VSD	SR	η [%]	N	[kW]	[m^3/h]	[Pa]	[RPM]
A	Static	No	1	31,7	40,0	0,495	2997	188	2454

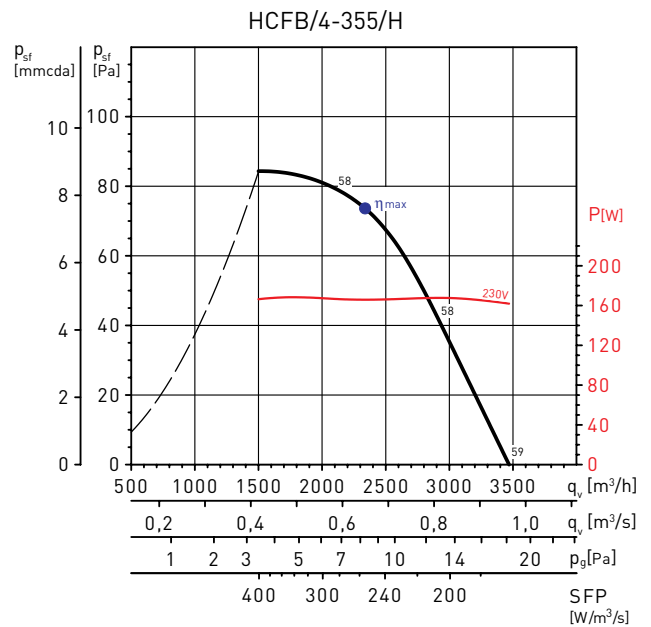
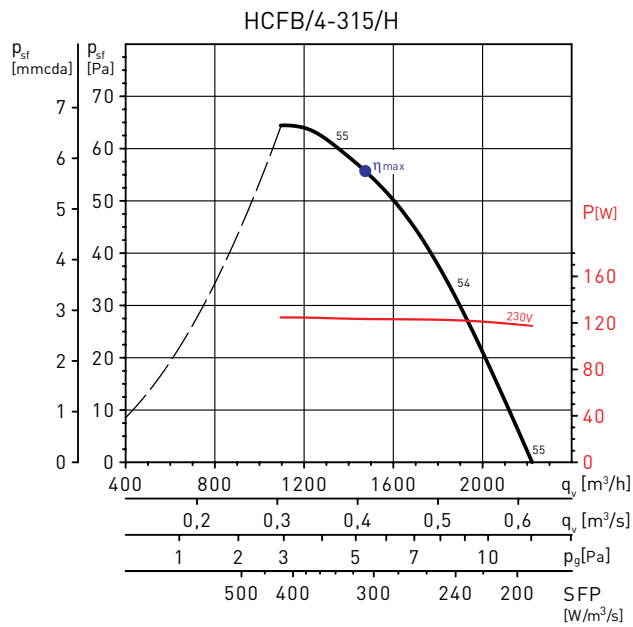

MC	EC	VSD	SR	η [%]	N	[kW]	[m^3/h]	[Pa]	[RPM]
A	Static	No	1	28,8	40,1	0,166	2339	74	1406

CURVAS CARACTERÍSTICAS - MOTORES DE 4 POLOS

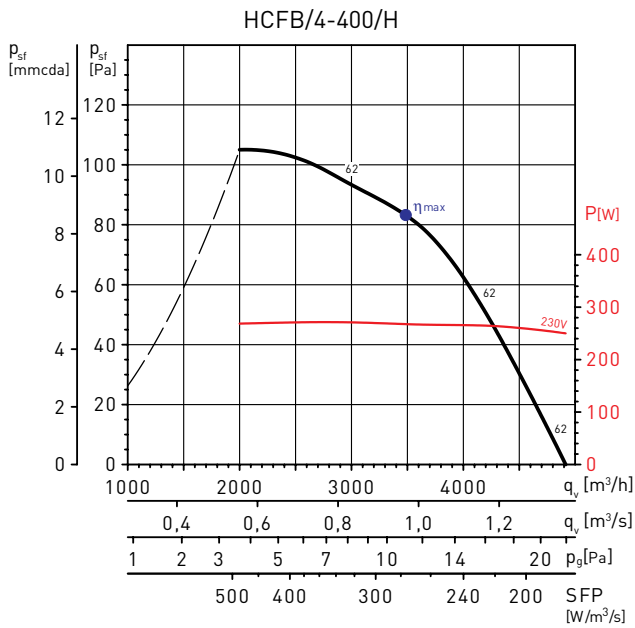

MC	EC	VSD	SR	η [%]	N	[kW]	[m³/h]	[Pa]	[RPM]
A	Static	No	1	30,1	40,0	0,268	3488	83	1411

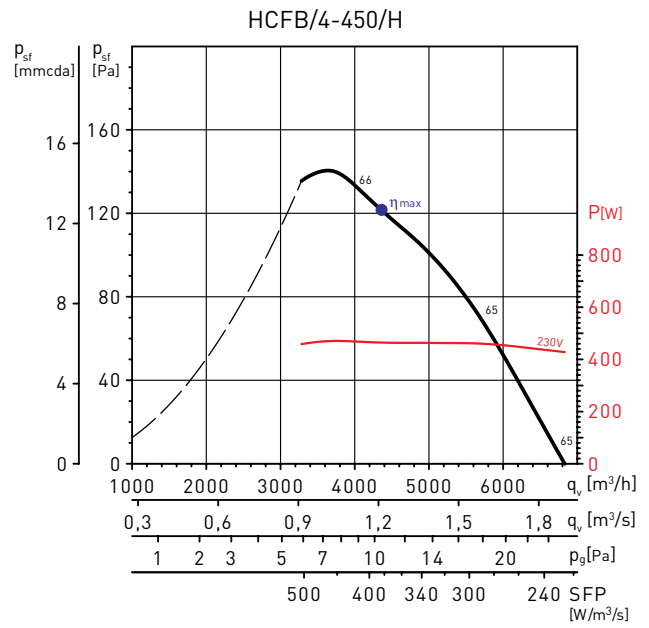

MC	EC	VSD	SR	η [%]	N	[kW]	[m³/h]	[Pa]	[RPM]
A	Static	No	1	31,7	40,1	0,466	4214	126	1351

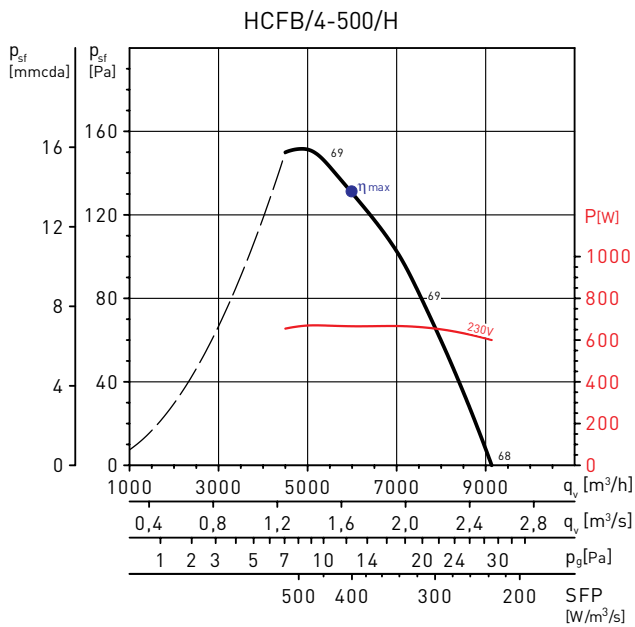

MC	EC	VSD	SR	η [%]	N	[kW]	[m³/h]	[Pa]	[RPM]
A	Static	No	1	32,8	40,2	0,667	5735	137	1351

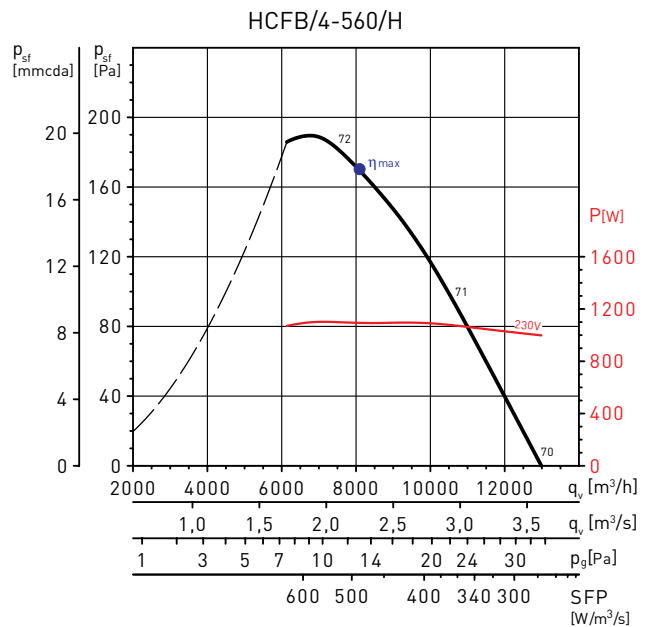

MC	EC	VSD	SR	η [%]	N	[kW]	[m³/h]	[Pa]	[RPM]
A	Static	No	1	34,9	41,0	1,093	8081	170	1386

CURVAS CARACTERÍSTICAS - MOTORES DE 4 POLOS

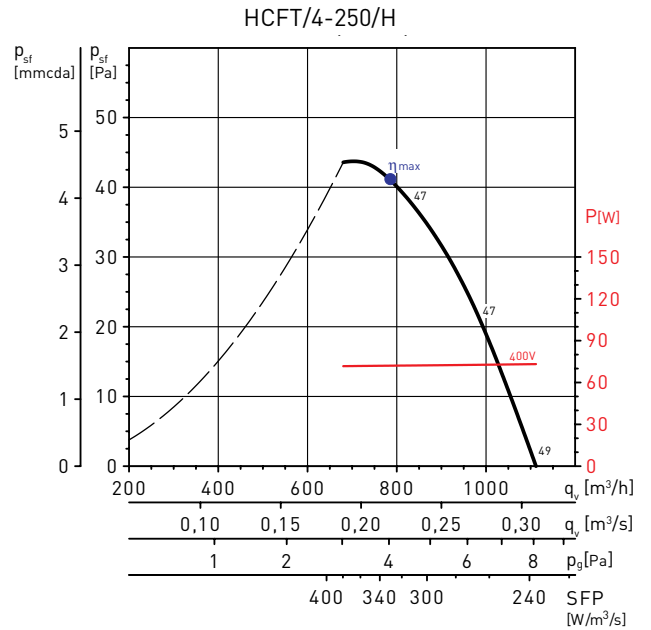
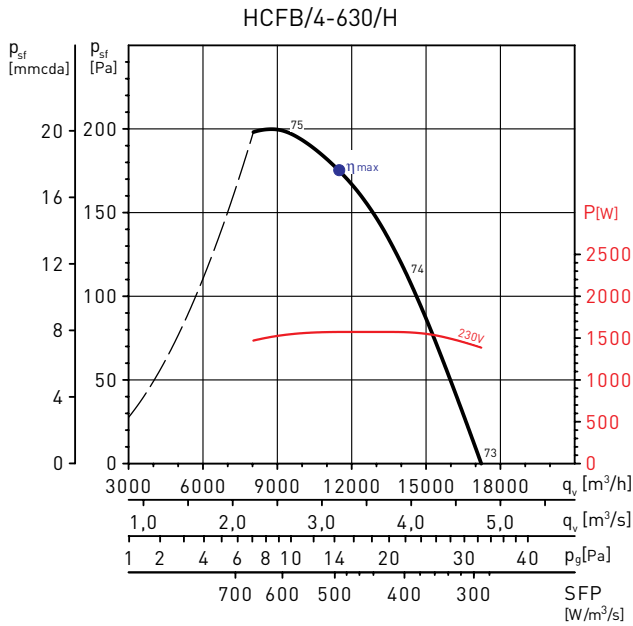

MC	EC	VSD	SR	η [%]	N	[kW]	[m³/h]	[Pa]	[RPM]
A	Static	No	1	35,5	40,6	1,573	11483	175	1345

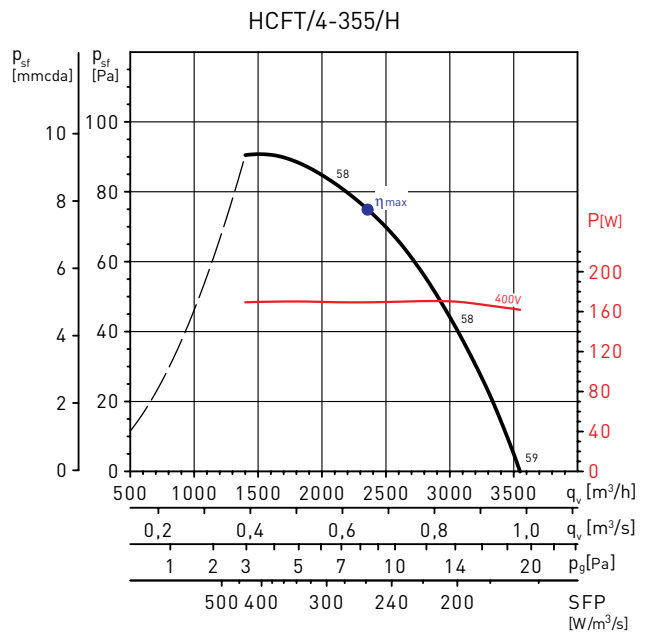
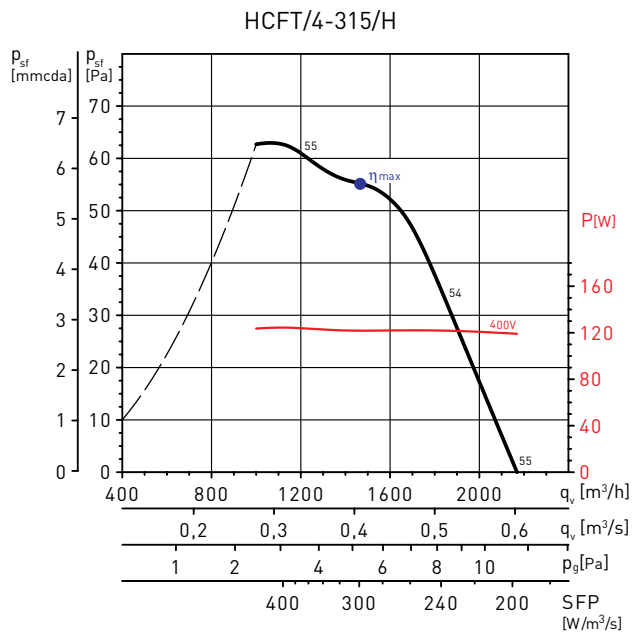

MC	EC	VSD	SR	η [%]	N	[kW]	[m³/h]	[Pa]	[RPM]
A	Static	No	1	29,0	40,2	0,169	2331	76	1379

CURVAS CARACTERÍSTICAS - MOTORES DE 4 POLOS

HCFT/4-400/H

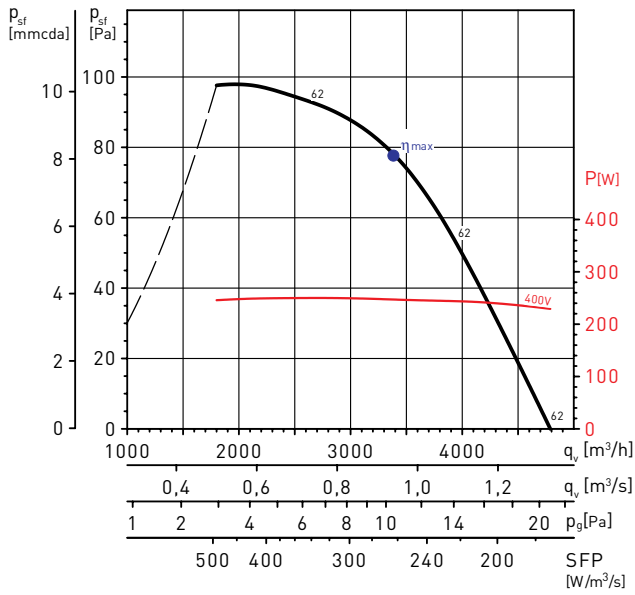

MC	EC	VSD	SR	η [%]	N	[kW]	[m ³ /h]	[Pa]	[RPM]
A	Static	No	1	29,8	40,0	0,248	3257	82	1354

HCFT/4-450/H

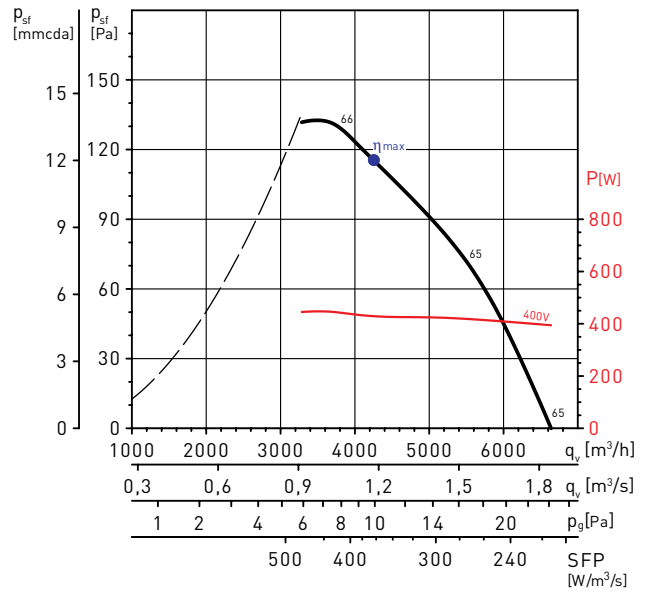

MC	EC	VSD	SR	η [%]	N	[kW]	[m ³ /h]	[Pa]	[RPM]
A	Static	No	1	31,8	40,5	0,429	4261	115	1351

HCFT/4-500/H

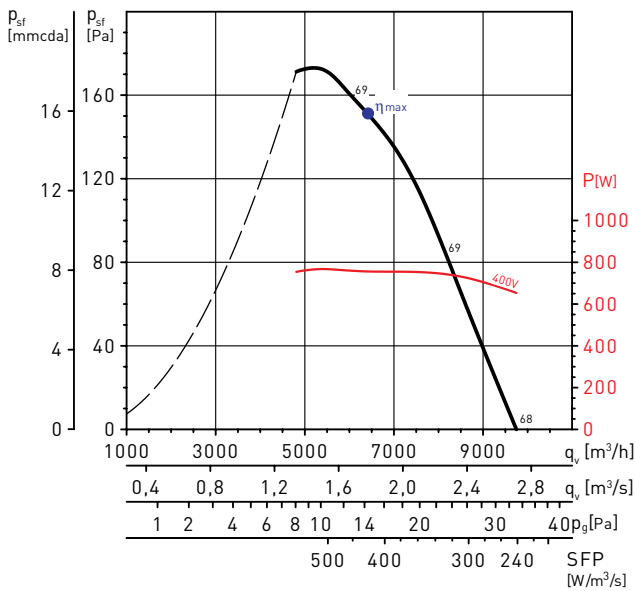

MC	EC	VSD	SR	η [%]	N	[kW]	[m ³ /h]	[Pa]	[RPM]
A	Static	No	1	35,7	42,8	0,756	6476	150	1449

HCFT/4-560/H

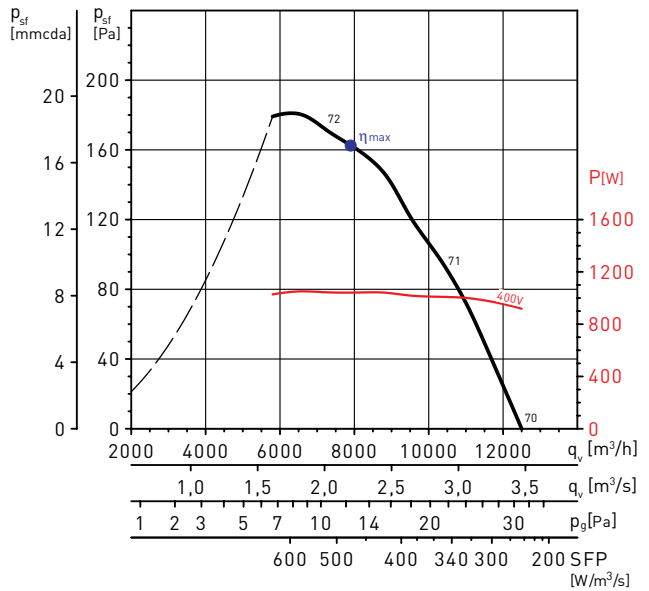

MC	EC	VSD	SR	η [%]	N	[kW]	[m ³ /h]	[Pa]	[RPM]
A	Static	No	1	34,9	41,1	1,045	8422	156	1377

CURVAS CARACTERÍSTICAS - MOTORES DE 4 POLOS

HCFT/4-630/H

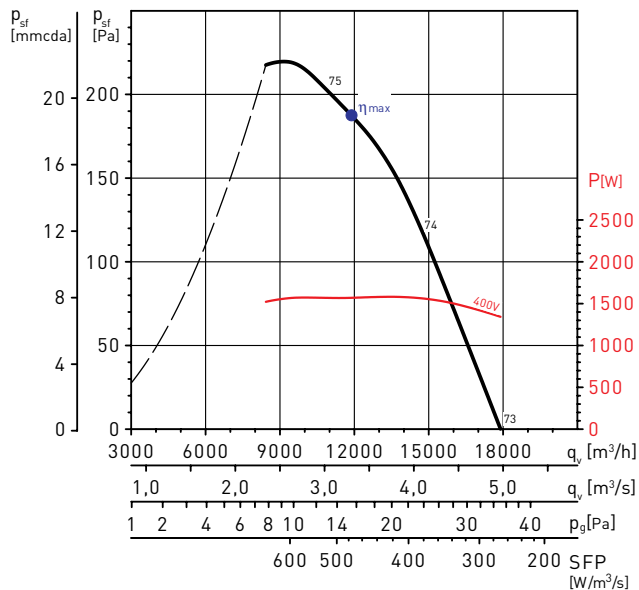

MC	EC	VSD	SR	η [%]	N	[kW]	[m ³ /h]	[Pa]	[RPM]
A	Static	No	1	39,5	44,6	1,569	11760	189	1404

HCFT/4-710/H

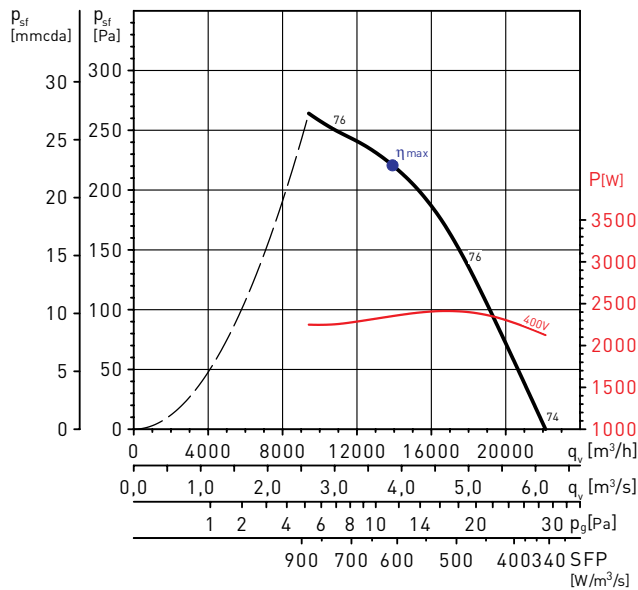

MC	EC	VSD	SR	η [%]	N	[kW]	[m ³ /h]	[Pa]	[RPM]
A	Static	No	1	36,3	40,3	2,352	13929	221	1354

HCFT/4-800/L

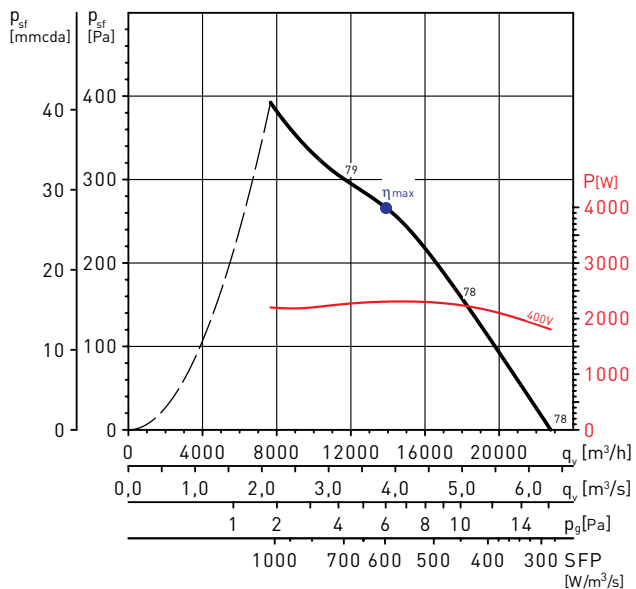

MC	EC	VSD	SR	η [%]	N	[kW]	[m ³ /h]	[Pa]	[RPM]
A	Static	No	1	44,7	48,7	2,305	13900	266	1392

HCFT/4-800/H

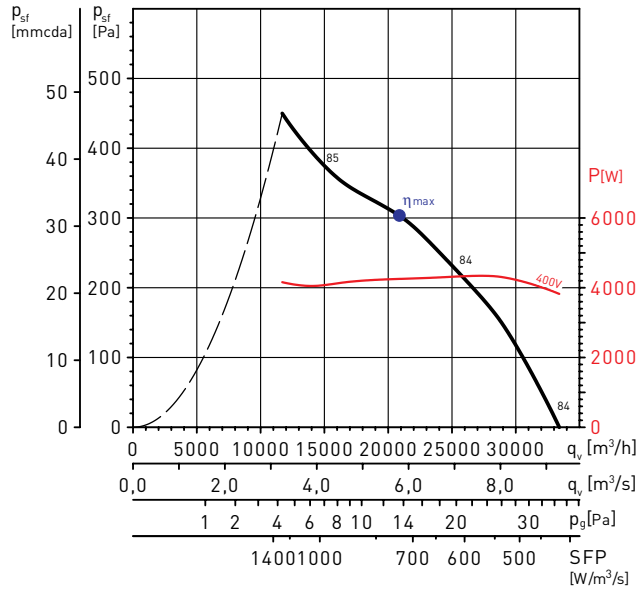

MC	EC	VSD	SR	η [%]	N	[kW]	[m ³ /h]	[Pa]	[RPM]
A	Static	No	1	41,4	43,8	4,253	20873	304	1435

CURVAS CARACTERÍSTICAS - MOTORES DE 4 POLOS

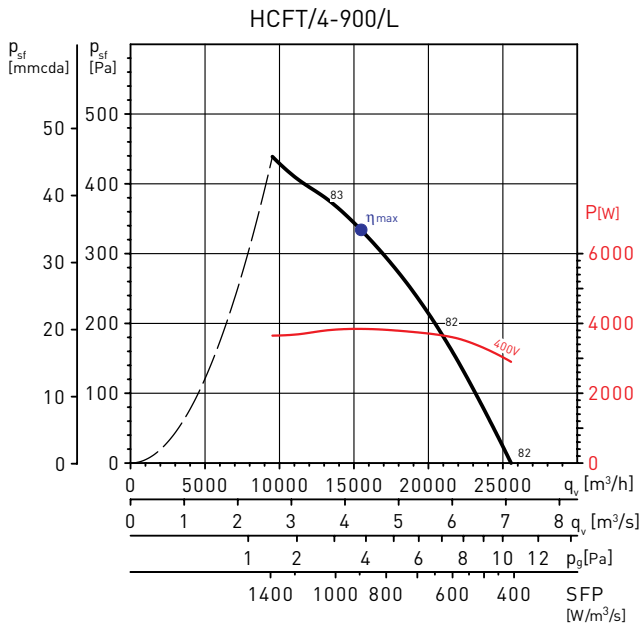

MC	EC	VSD	SR	η[%]	N	[kW]	[m³/h]	[Pa]	[RPM]
A	Static	No	1	37,4	40,0	3,844	15455	334	1442

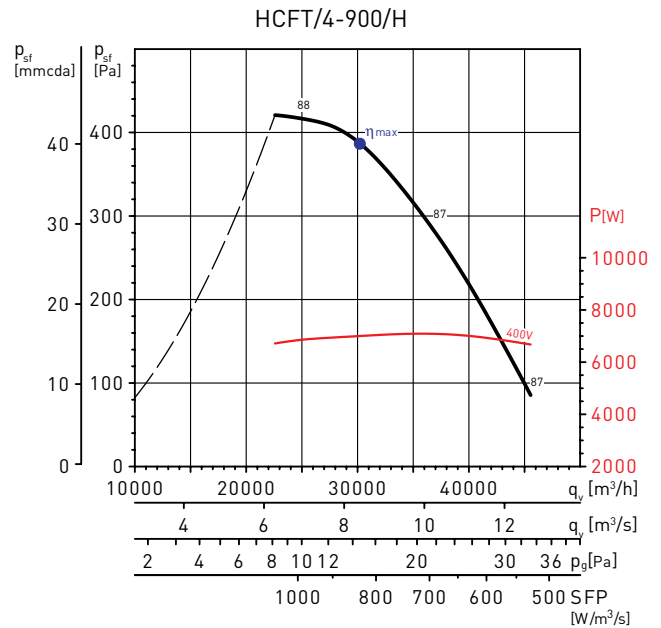

MC	EC	VSD	SR	η[%]	N	[kW]	[m³/h]	[Pa]	[RPM]
A	Static	No	1	46,3	47,3	7,001	30198	387	1455

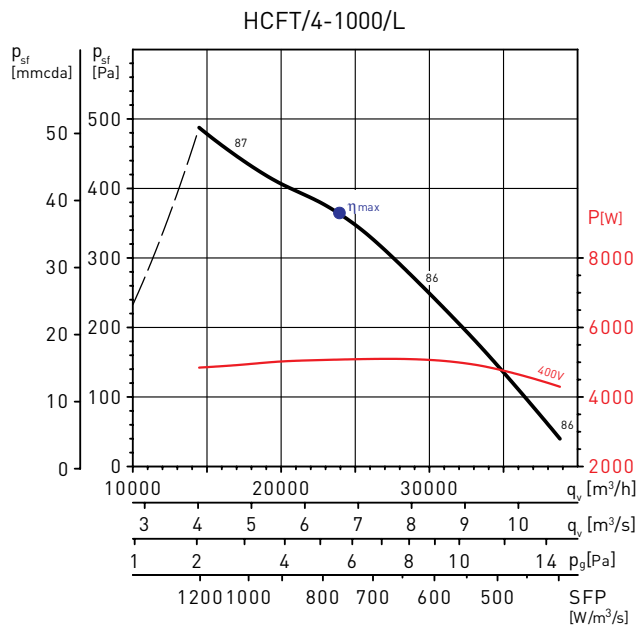

MC	EC	VSD	SR	η[%]	N	[kW]	[m³/h]	[Pa]	[RPM]
A	Static	No	1	47,6	49,5	5,076	23915	364	1421

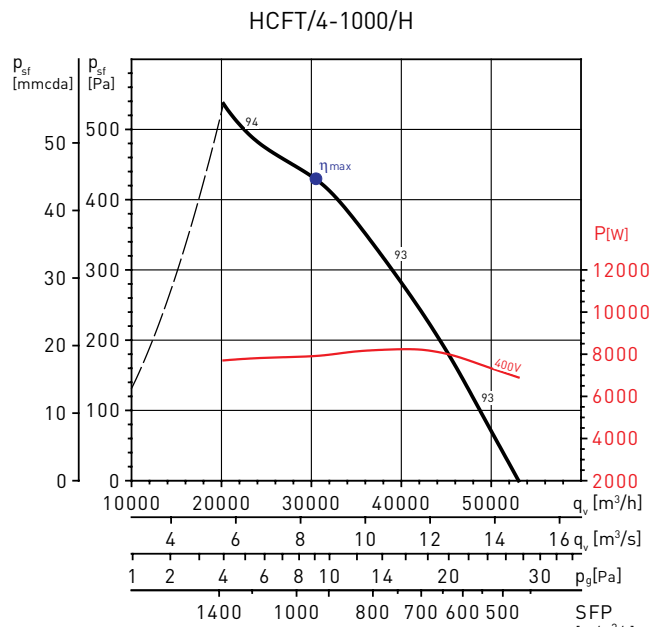

MC	EC	VSD	SR	η[%]	N	[kW]	[m³/h]	[Pa]	[RPM]
A	Static	No	1	46,1	46,8	7,912	30528	430	1469

CURVAS CARACTERÍSTICAS - MOTORES DE 6 POLOS

HCFB/6-315/H

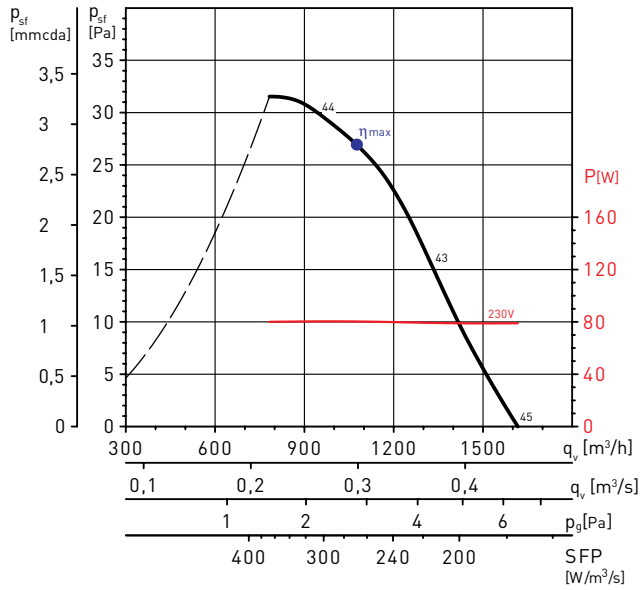

HCFB/6-355/H

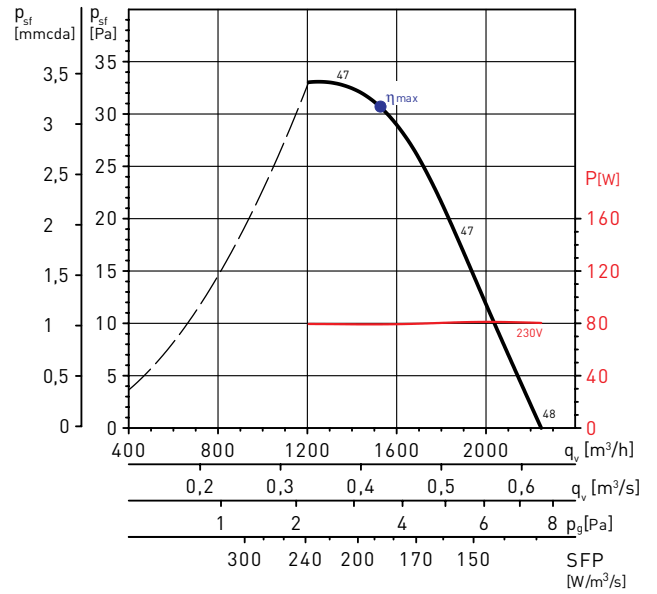

HCFB/6-400/H

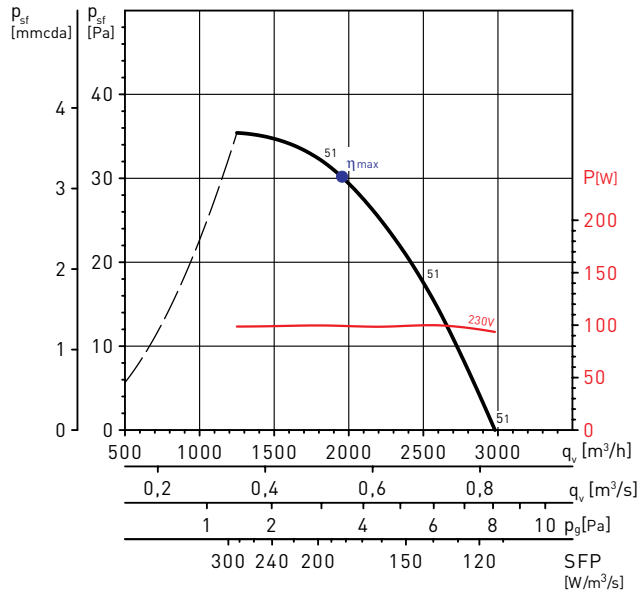

HCFB/6-450/H

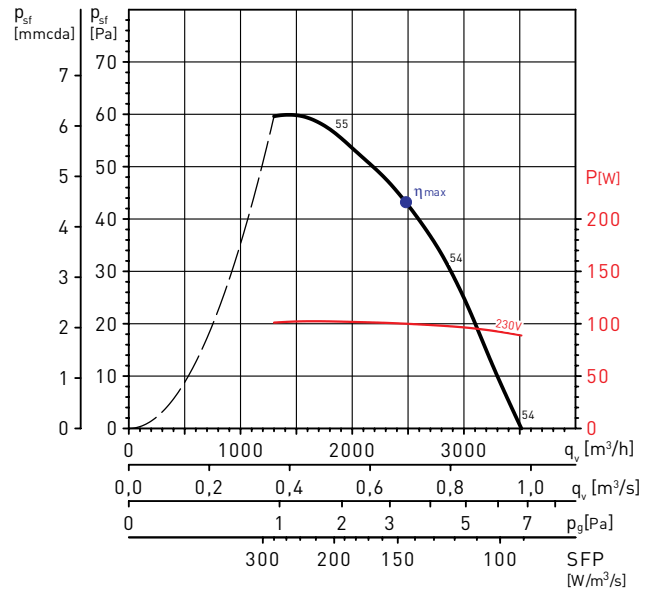

MC	EC	VSD	SR	η [%]	N	[kW]	[m³/h]	[Pa]	[RPM]
A	Static	No	1	30,2	42,8	0,101	2327	47	885

CURVAS CARACTERÍSTICAS - MOTORES DE 6 POLOS

HCFB/6-500/H

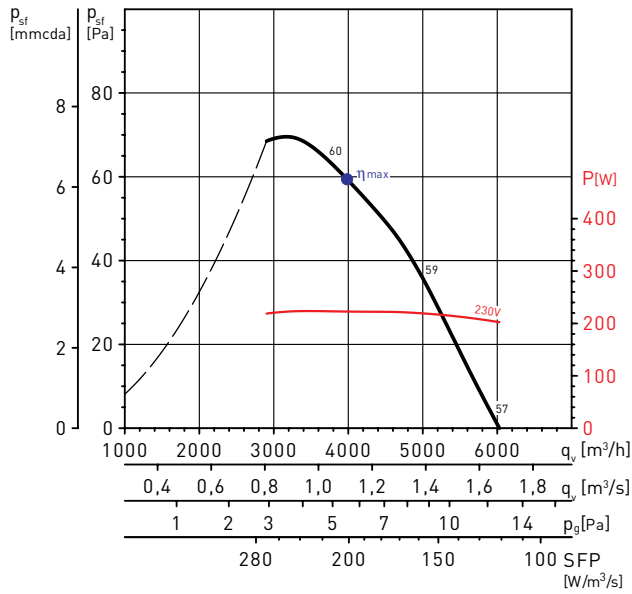

MC	EC	VSD	SR	η [%]	N	[kW]	[m^3/h]	[Pa]	[RPM]
A	Static	No	1	29,7	40,1	0,223	3783	63	904

HCFB/6-560/H

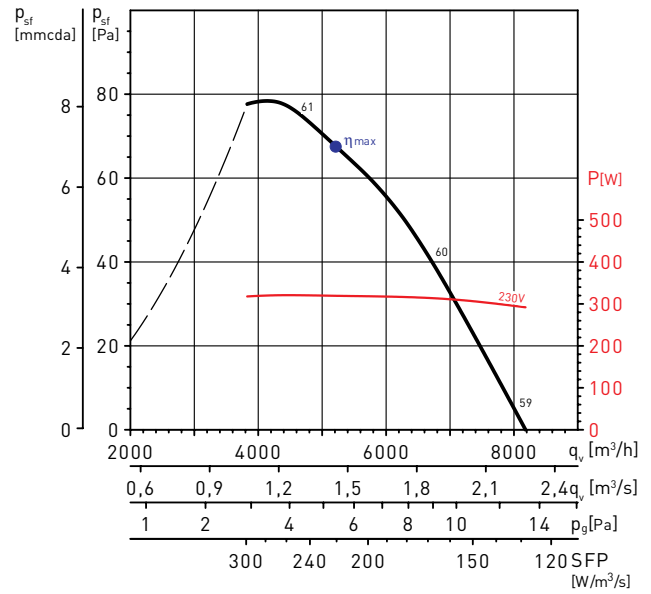

MC	EC	VSD	SR	η [%]	N	[kW]	[m^3/h]	[Pa]	[RPM]
A	Static	No	1	30,7	40,2	0,319	5214	68	880

HCFB/6-630/H

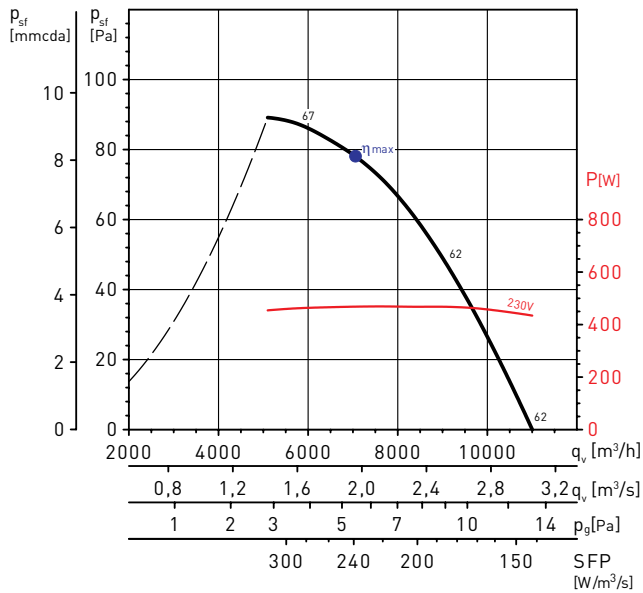

MC	EC	VSD	SR	η [%]	N	[kW]	[m^3/h]	[Pa]	[RPM]
A	Static	No	1	32,7	41,1	0,469	7230	76	899

HCFT/6-355/H

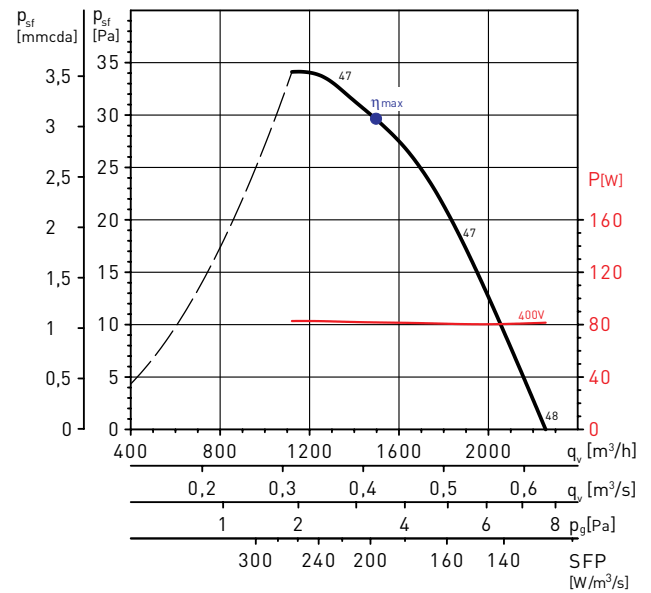

MC	EC	VSD	SR	η [%]	N	[kW]	[m^3/h]	[Pa]	[RPM]
A	Static	No	1	32,7	41,1	0,469	7230	76	899

CURVAS CARACTERÍSTICAS - MOTORES DE 6 POLOS

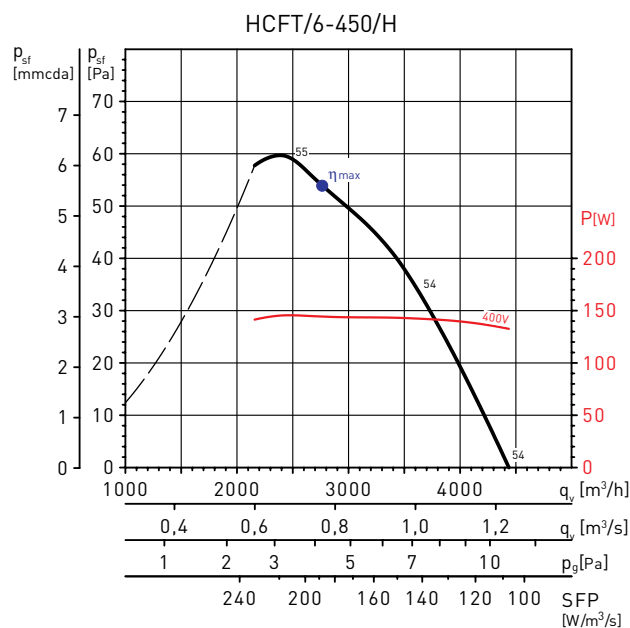
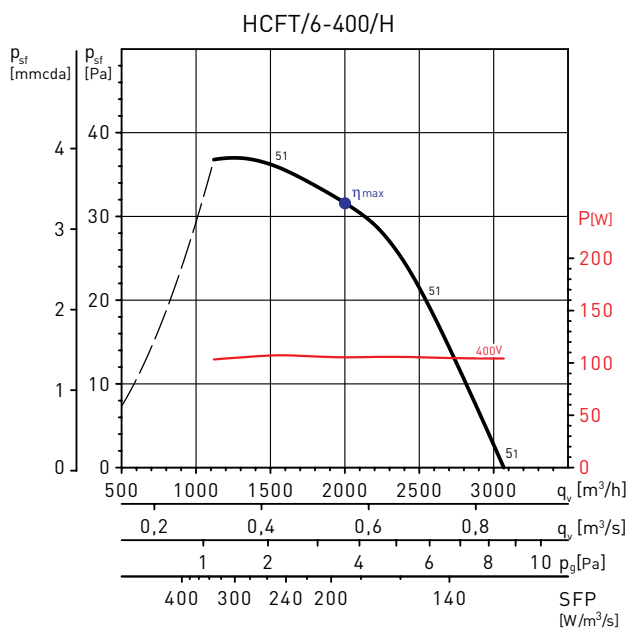

MC	EC	VSD	SR	η [%]	N	[kW]	[m³/h]	[Pa]	[RPM]
A	Static	No	1	28,8	40,4	0,144	2920	51	897

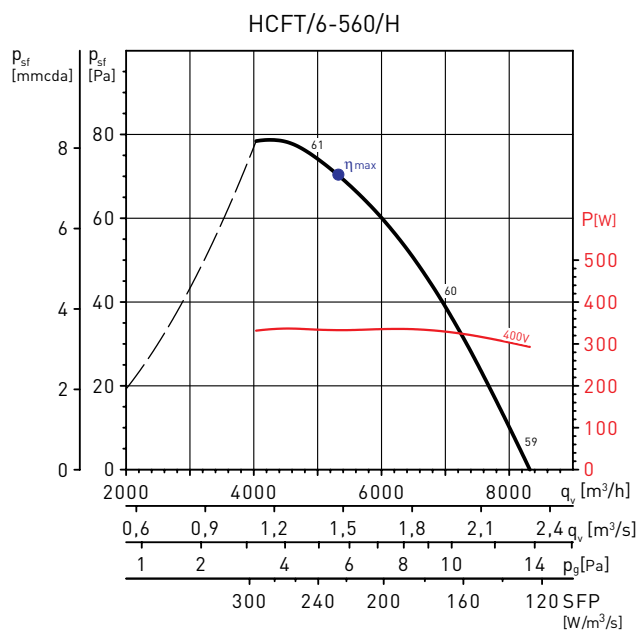
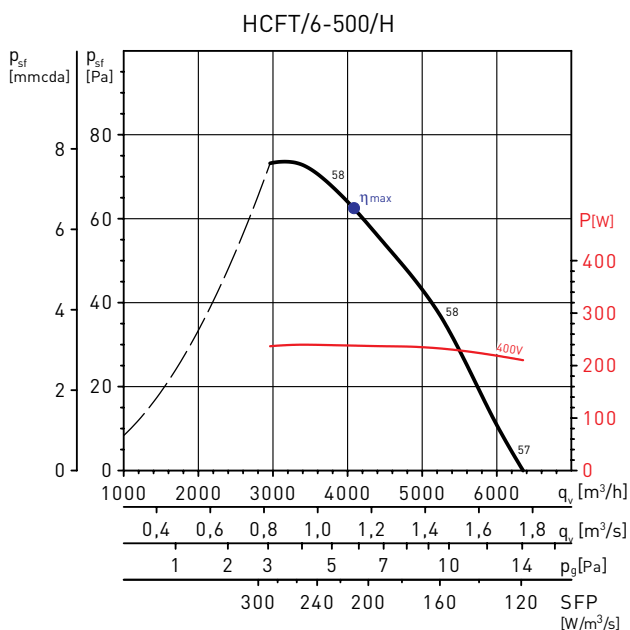

MC	EC	VSD	SR	η [%]	N	[kW]	[m³/h]	[Pa]	[RPM]
A	Static	No	1	29,9	40,2	0,239	3900	66	903

MC	EC	VSD	SR	η [%]	N	[kW]	[m³/h]	[Pa]	[RPM]
A	Static	No	1	31,2	40,5	0,333	5333	70	905

CURVAS CARACTERÍSTICAS - MOTORES DE 6 POLOS

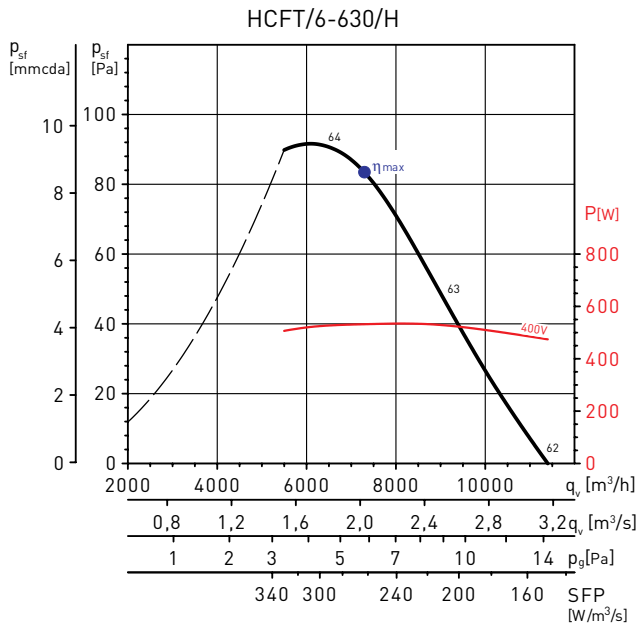

MC	EC	VSD	SR	η [%]	N	[kW]	[m³/h]	[Pa]	[RPM]
A	Static	No	1	31,9	40,0	0,531	7080	86	904

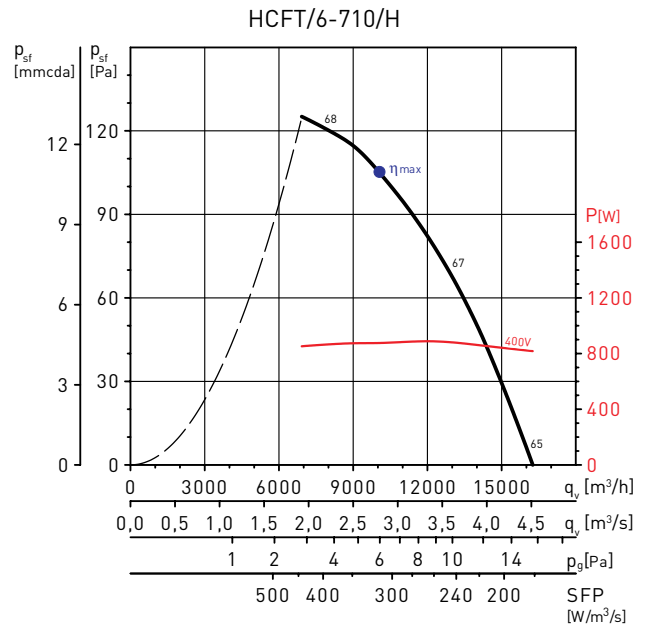

MC	EC	VSD	SR	η [%]	N	[kW]	[m³/h]	[Pa]	[RPM]
A	Static	No	1	33,5	40,2	0,876	10055	105	949

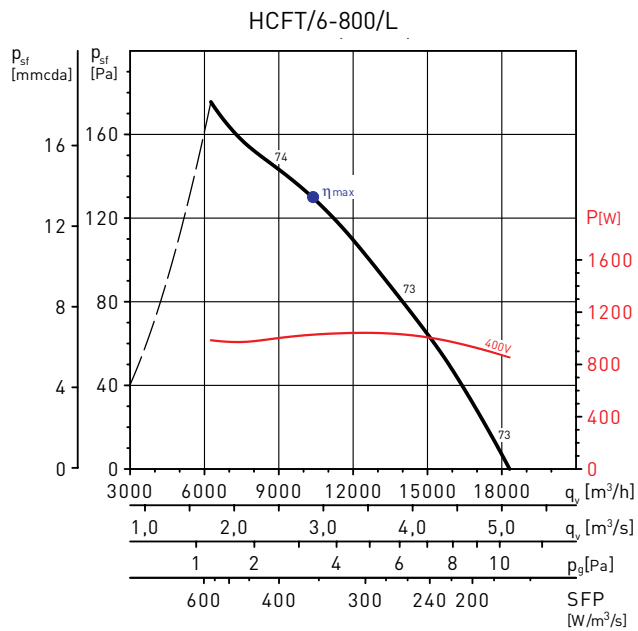

MC	EC	VSD	SR	η [%]	N	[kW]	[m³/h]	[Pa]	[RPM]
A	Static	No	1	36,4	42,7	1,028	10372	130	922

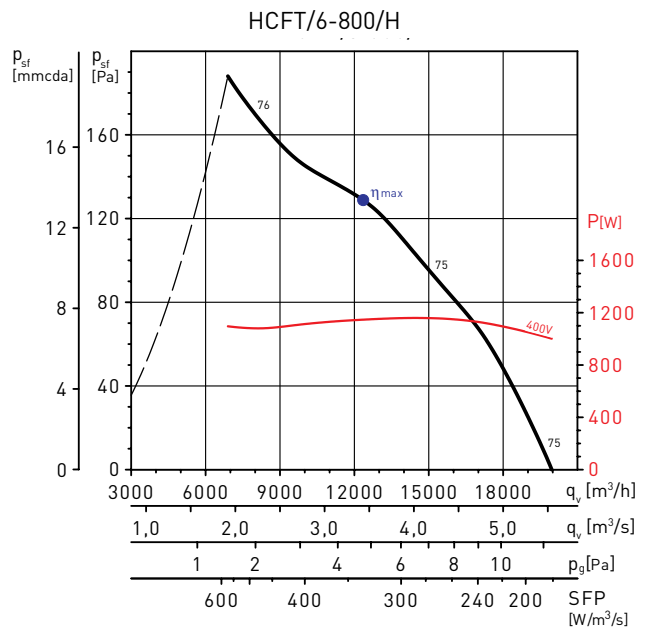

MC	EC	VSD	SR	η [%]	N	[kW]	[m³/h]	[Pa]	[RPM]
A	Static	No	1	38,7	44,7	1,147	12360	129	931

CURVAS CARACTERÍSTICAS - MOTORES DE 6 POLOS

HCFT/6-900/L

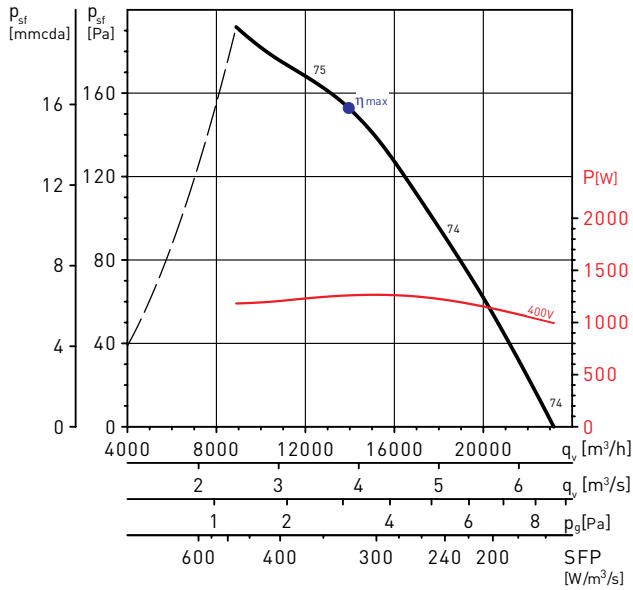

MC	EC	VSD	SR	η [%]	N	[kW]	[m^3/h]	[Pa]	[RPM]
A	Static	No	1	47,1	52,8	1,260	13960	153	954

HCFT/6-900/H

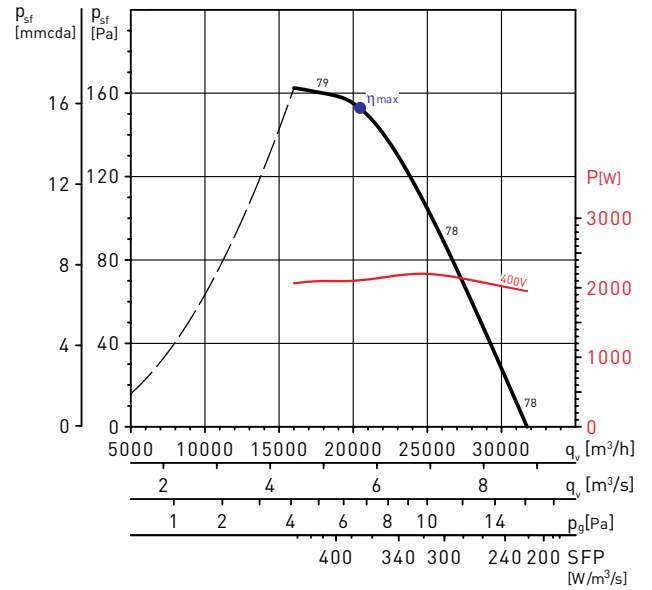

MC	EC	VSD	SR	η [%]	N	[kW]	[m^3/h]	[Pa]	[RPM]
A	Static	No	1	41,2	45,5	2,107	20461	153	947

HCFT/6-1000/L

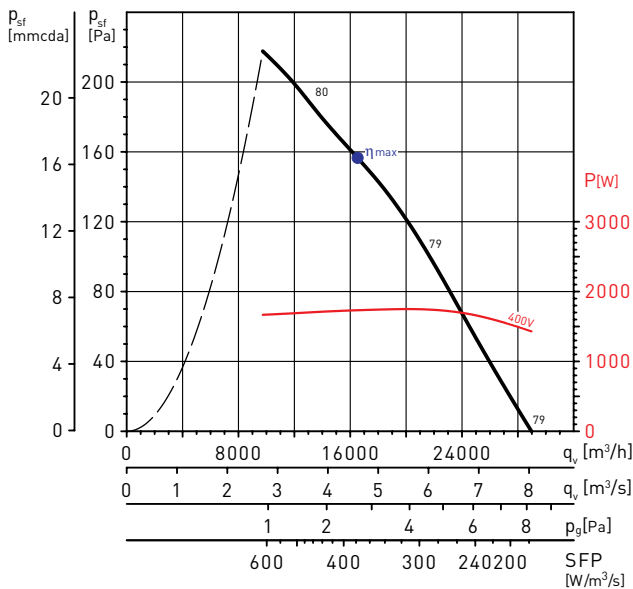

MC	EC	VSD	SR	η [%]	N	[kW]	[m^3/h]	[Pa]	[RPM]
A	Static	No	1	41,6	46,4	1,733	16522	157	926

HCFT/6-1000/H

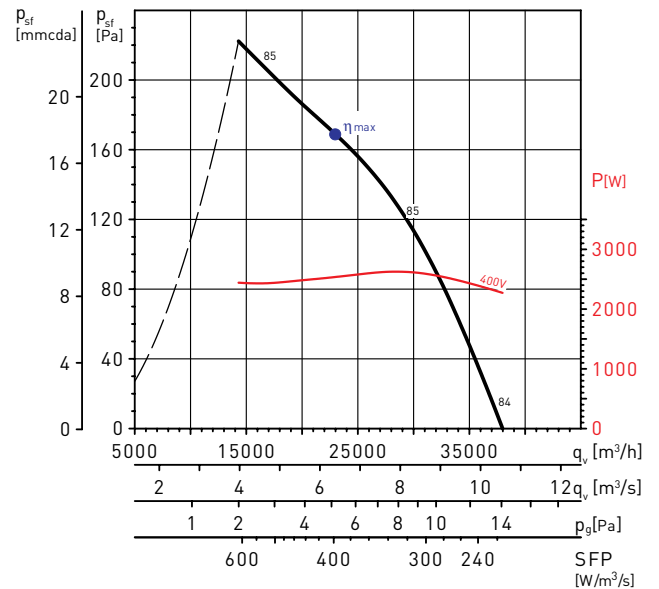

MC	EC	VSD	SR	η [%]	N	[kW]	[m^3/h]	[Pa]	[RPM]
A	Static	No	1	42,6	46,4	2,536	22959	169	931

CURVAS CARACTERÍSTICAS - MOTORES DE 4 POLOS

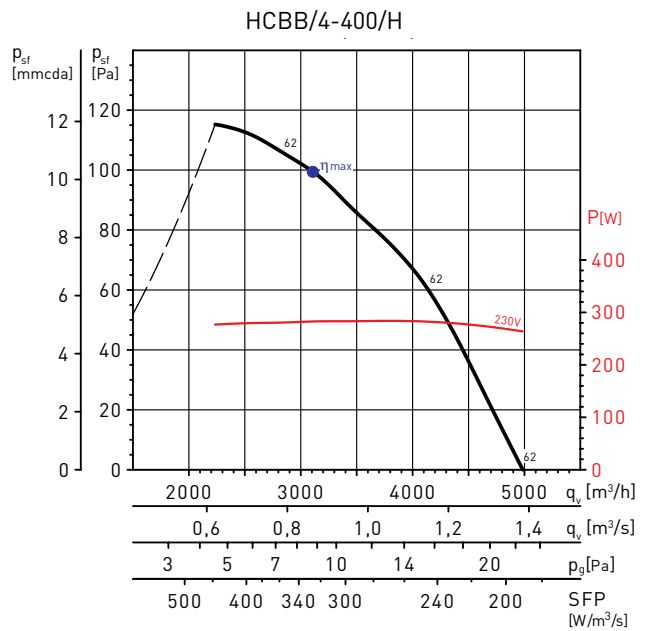
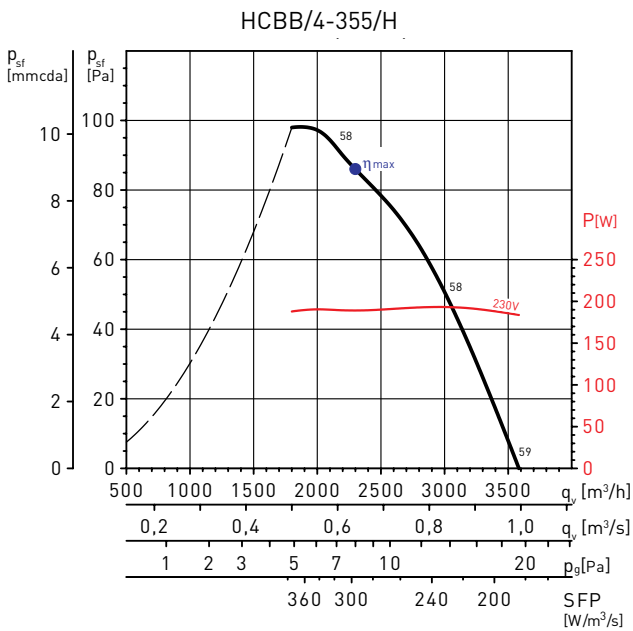
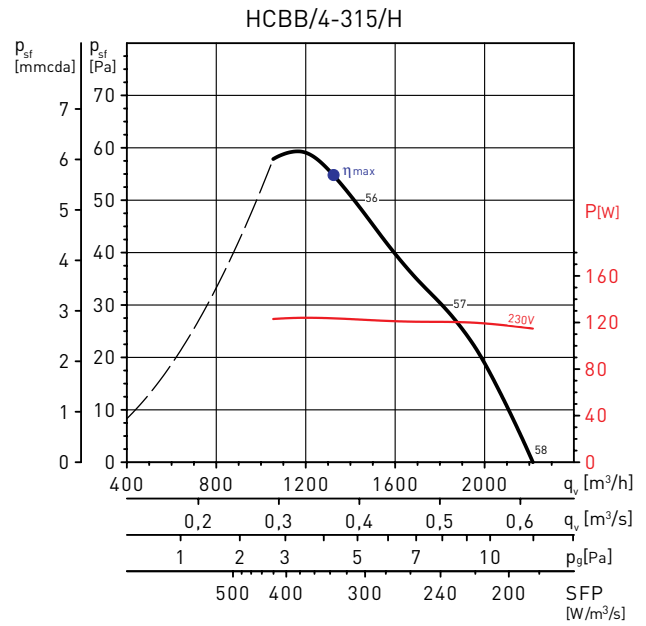
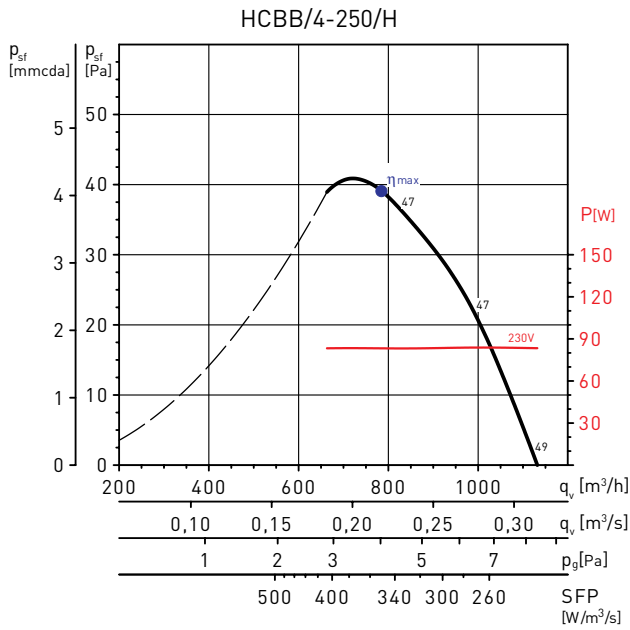

MC	EC	VSD	SR	η [%]	N	[kW]	[m^3/h]	[Pa]	[RPM]
A	Static	No	1	29,1	40,0	0,189	2300	86	1377

MC	EC	VSD	SR	η [%]	N	[kW]	[m^3/h]	[Pa]	[RPM]
A	Static	No	1	30,4	40,2	0,283	3107	100	1327

CURVAS CARACTERÍSTICAS - MOTORES DE 4 POLOS

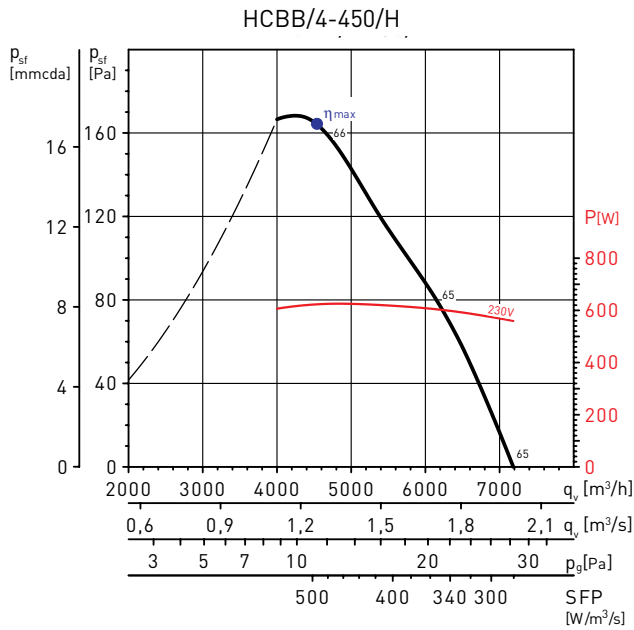

MC	EC	VSD	SR	η [%]	N	[kW]	[m³/h]	[Pa]	[RPM]
A	Static	No	1	33,2	40,8	0,623	4538	164	1390

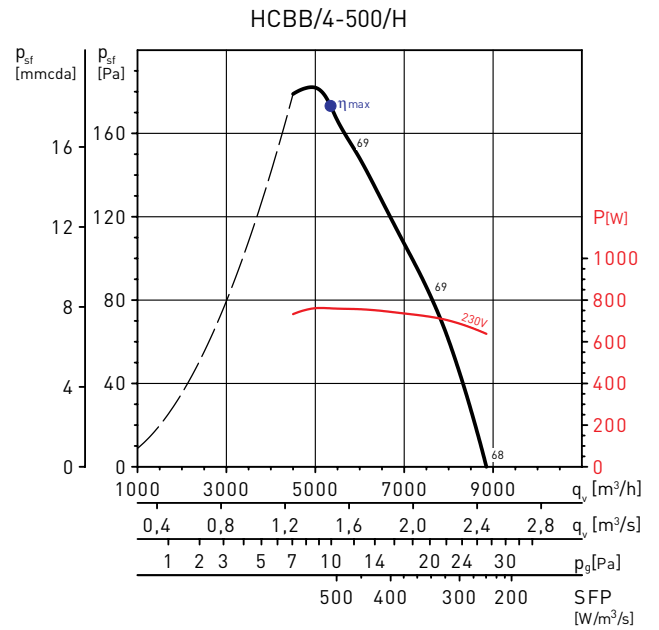

MC	EC	VSD	SR	η [%]	N	[kW]	[m³/h]	[Pa]	[RPM]
A	Static	No	1	33,6	40,7	0,760	5336	172	1322

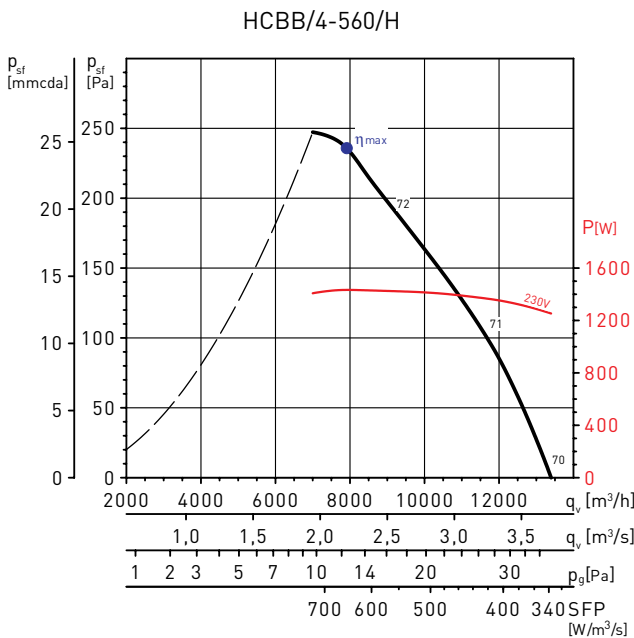

MC	EC	VSD	SR	η [%]	N	[kW]	[m³/h]	[Pa]	[RPM]
A	Static	No	1	36,0	41,3	1,433	7896	235	1367

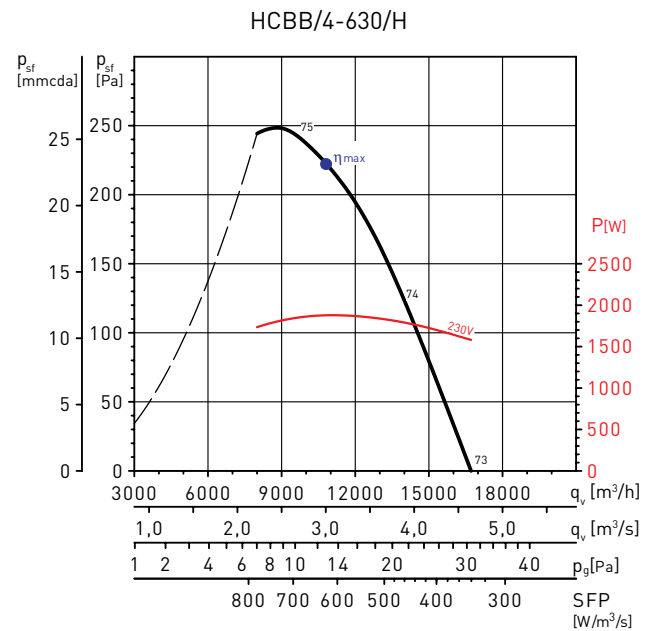

MC	EC	VSD	SR	η [%]	N	[kW]	[m³/h]	[Pa]	[RPM]
A	Static	No	1	35,6	40,2	1,878	10817	223	1305

CURVAS CARACTERÍSTICAS - MOTORES DE 4 POLOS

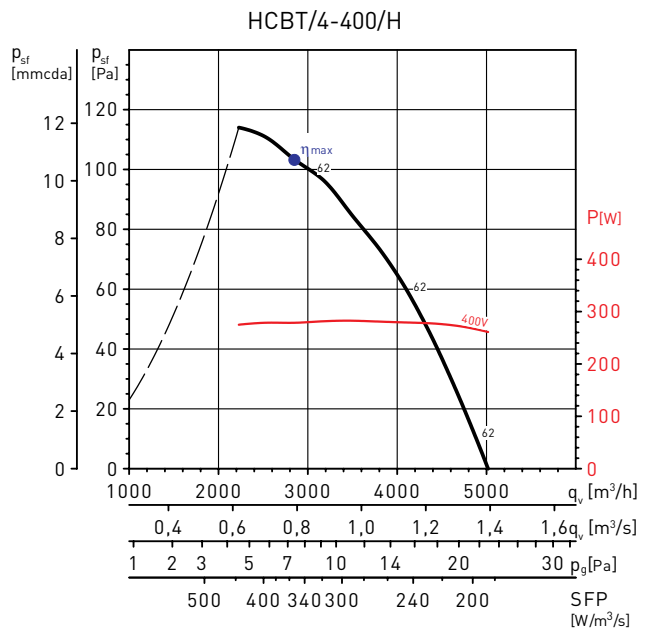
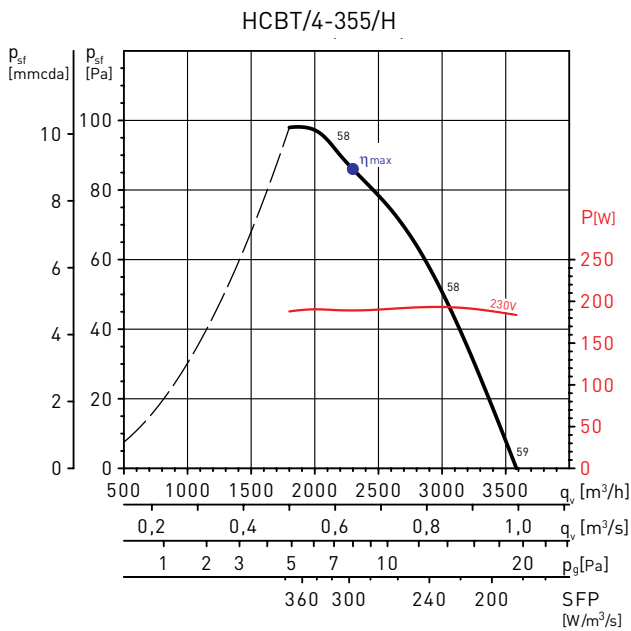
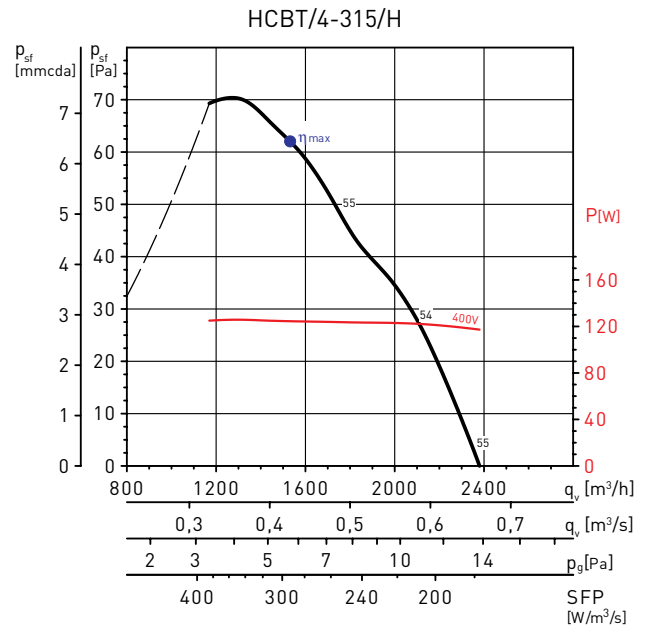
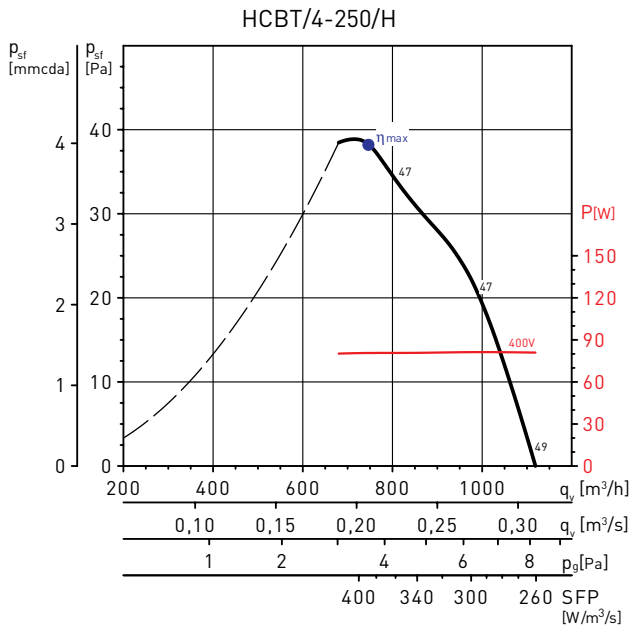

MC	EC	VSD	SR	η[%]	N	[kW]	[m³/h]	[Pa]	[RPM]
A	Static	No	1	29,0	40,0	0,179	2163	86	1372

MC	EC	VSD	SR	η[%]	N	[kW]	[m³/h]	[Pa]	[RPM]
A	Static	No	1	30,2	40,0	0,281	3127	98	1332

CURVAS CARACTERÍSTICAS - MOTORES DE 4 POLOS

HCBT/4-450/H

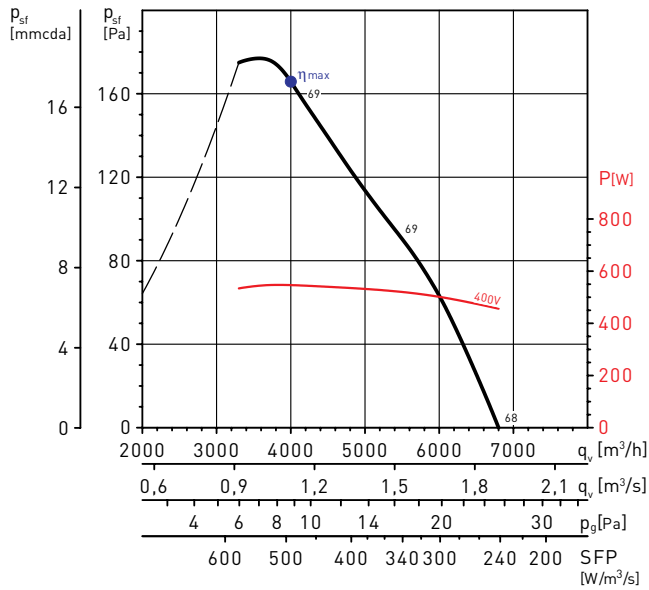

MC	EC	VSD	SR	η [%]	N	[kW]	[m ³ /h]	[Pa]	[RPM]
A	Static	No	1	33,6	41,3	0,605	4179	175	1391

HCBT/4-500/H

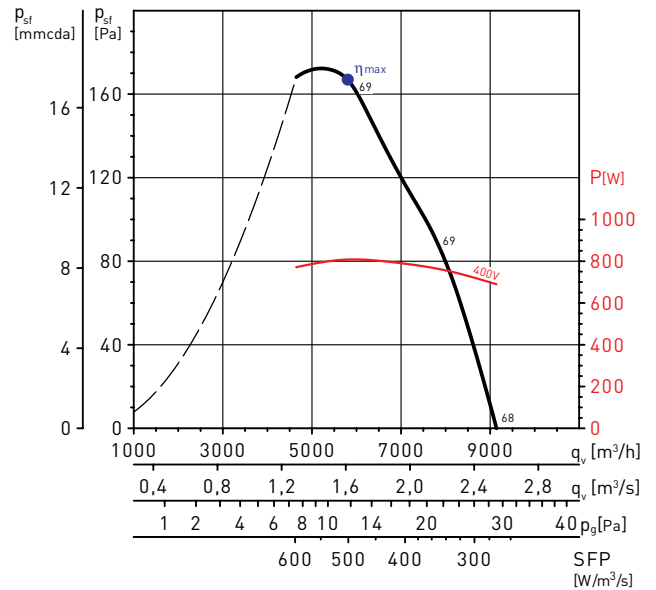

MC	EC	VSD	SR	η [%]	N	[kW]	[m ³ /h]	[Pa]	[RPM]
A	Static	No	1	33,1	40,0	0,808	5793	167	1357

HCBT/4-560/H

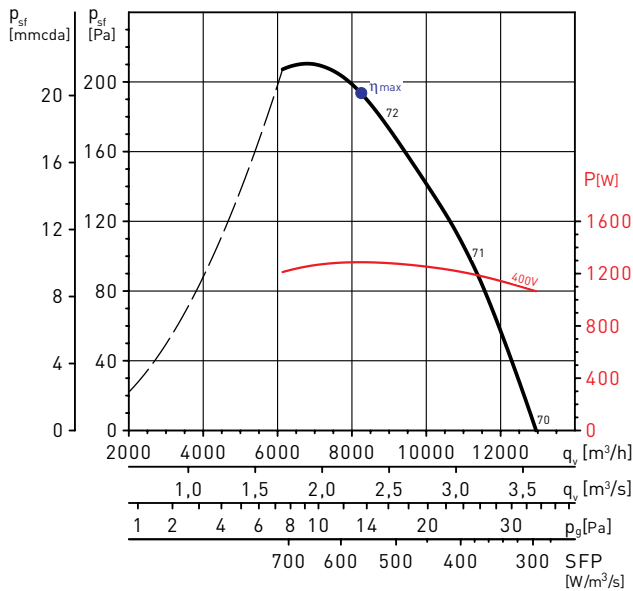

MC	EC	VSD	SR	η [%]	N	[kW]	[m ³ /h]	[Pa]	[RPM]
A	Static	No	1	34,4	40,0	1,287	8244	194	1349

HCBT/4-630/H

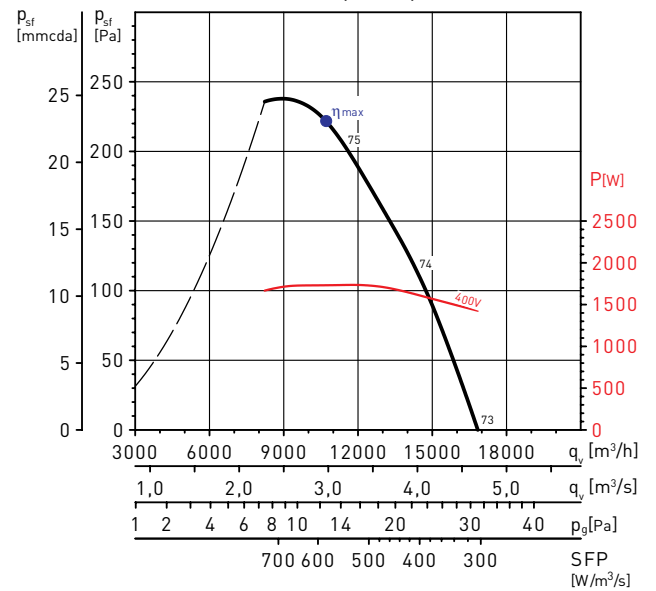

MC	EC	VSD	SR	η [%]	N	[kW]	[m ³ /h]	[Pa]	[RPM]
A	Static	No	1	38,1	42,9	1,731	10708	222	1355

CURVAS CARACTERÍSTICAS - MOTORES DE 4 POLOS

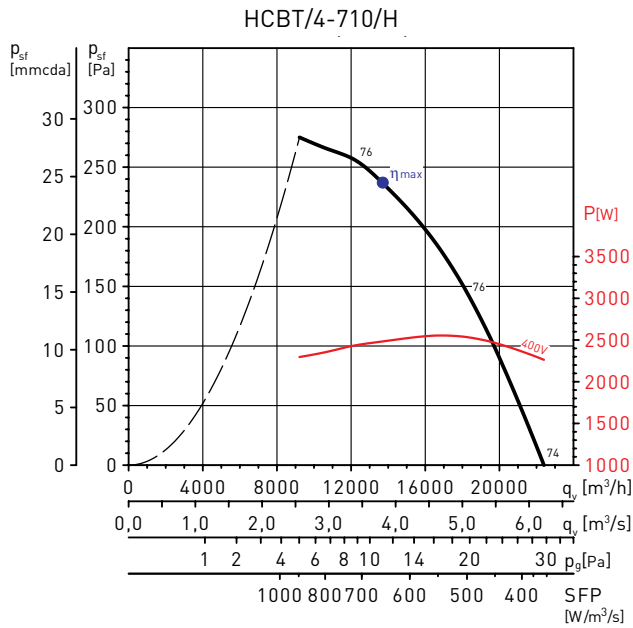

MC	EC	VSD	SR	η[%]	N	[kW]	[m³/h]	[Pa]	[RPM]
A	Static	No	1	36,3	40,1	2,483	13700	237	1326

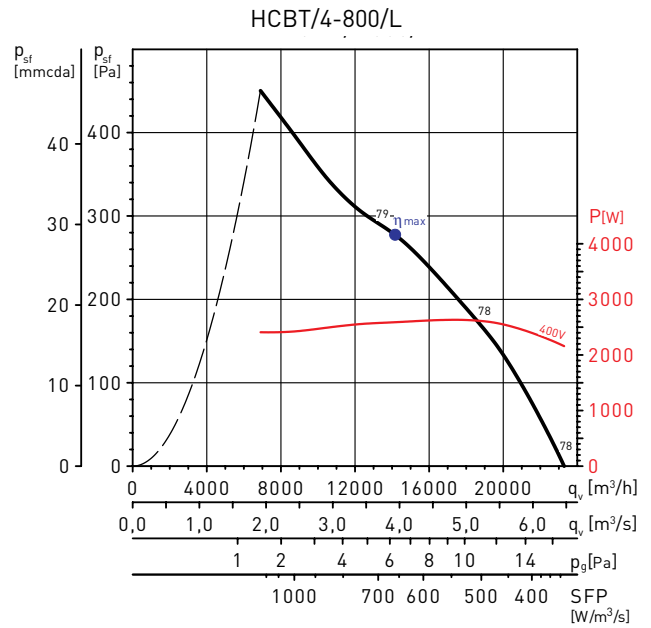

MC	EC	VSD	SR	η[%]	N	[kW]	[m³/h]	[Pa]	[RPM]
A	Static	No	1	42,2	45,9	2,589	14152	278	1376

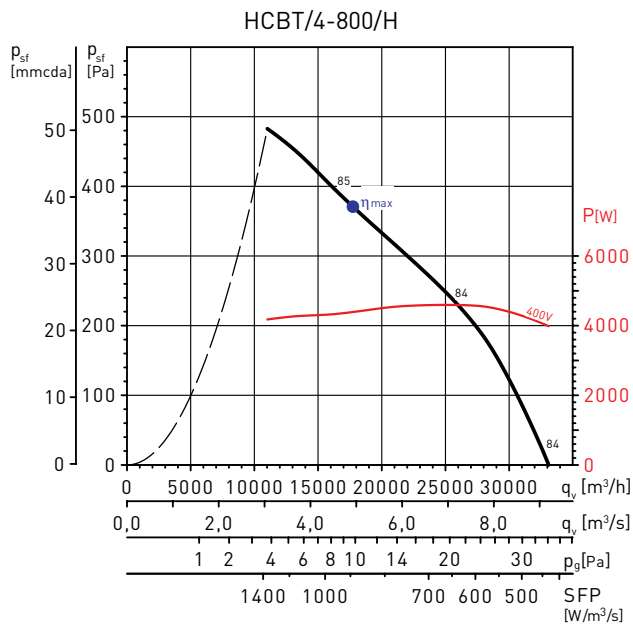

MC	EC	VSD	SR	η[%]	N	[kW]	[m³/h]	[Pa]	[RPM]
A	Static	No	1	41,7	44,0	4,389	17734	371	1431

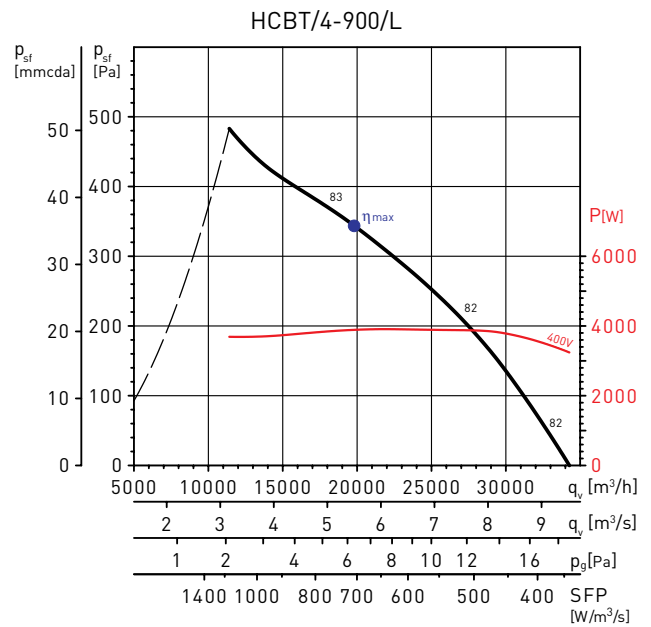

MC	EC	VSD	SR	η[%]	N	[kW]	[m³/h]	[Pa]	[RPM]
A	Static	No	1	48,6	51,2	3,889	19789	344	1436

CURVAS CARACTERÍSTICAS - MOTORES DE 4 POLOS

HCBT/4-900/H

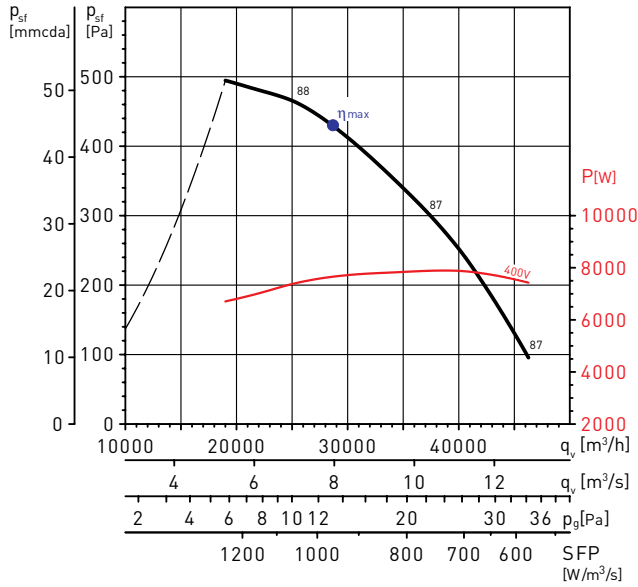

MC	EC	VSD	SR	η[%]	N	[kW]	[m ³ /h]	[Pa]	[RPM]
A	Static	No	1	44,7	45,5	7,657	28654	430	1446

HCBT/4-1000/L

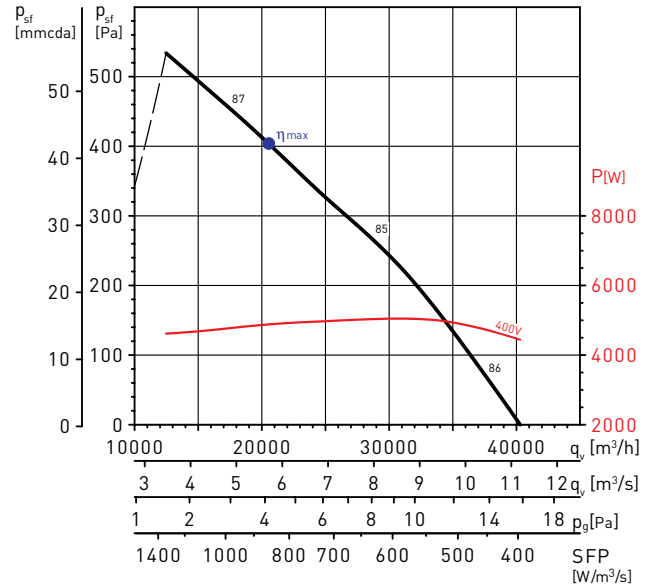

MC	EC	VSD	SR	η[%]	N	[kW]	[m ³ /h]	[Pa]	[RPM]
A	Static	No	1	47,2	49,2	4,883	20544	404	1402

HCBT/4-1000/H

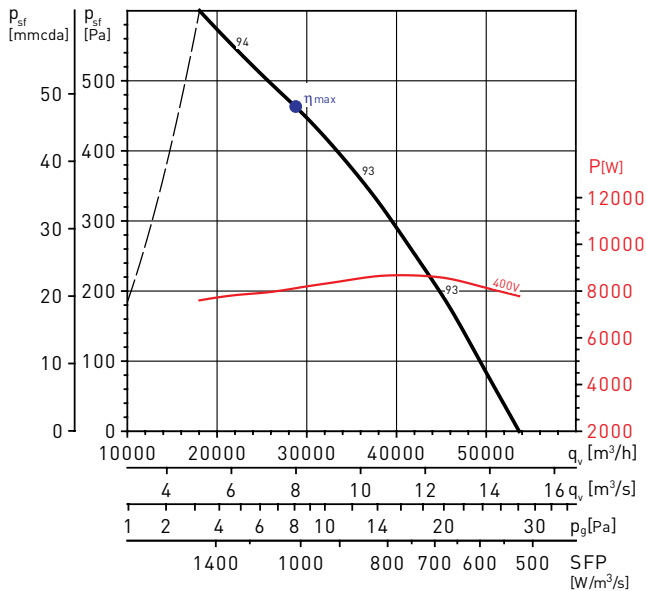

MC	EC	VSD	SR	η[%]	N	[kW]	[m ³ /h]	[Pa]	[RPM]
A	Static	No	1	45,5	46,1	8,132	28765	463	1467

CURVAS CARACTERÍSTICAS - MOTORES DE 6 POLOS

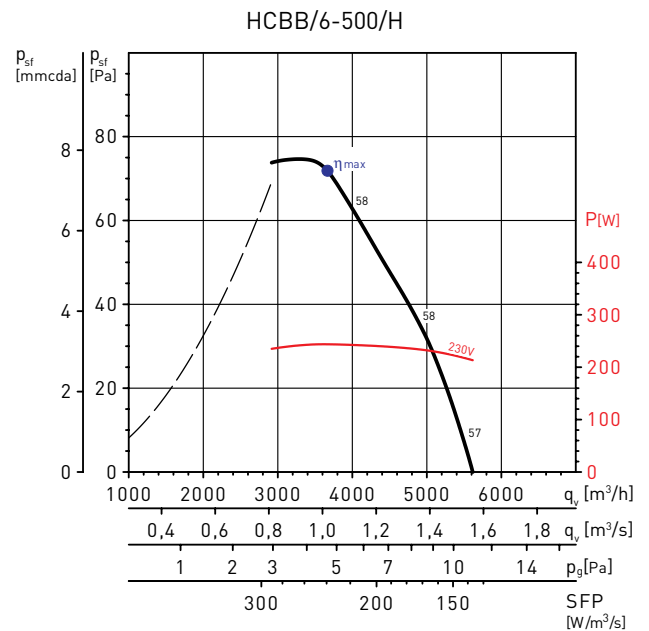
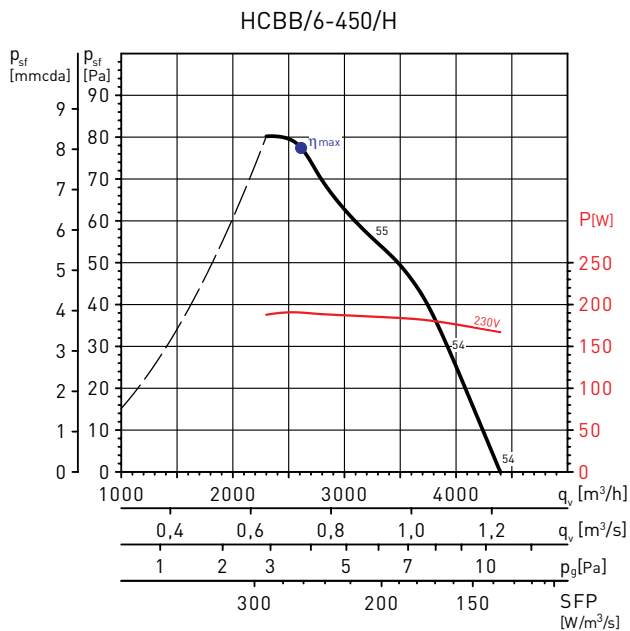
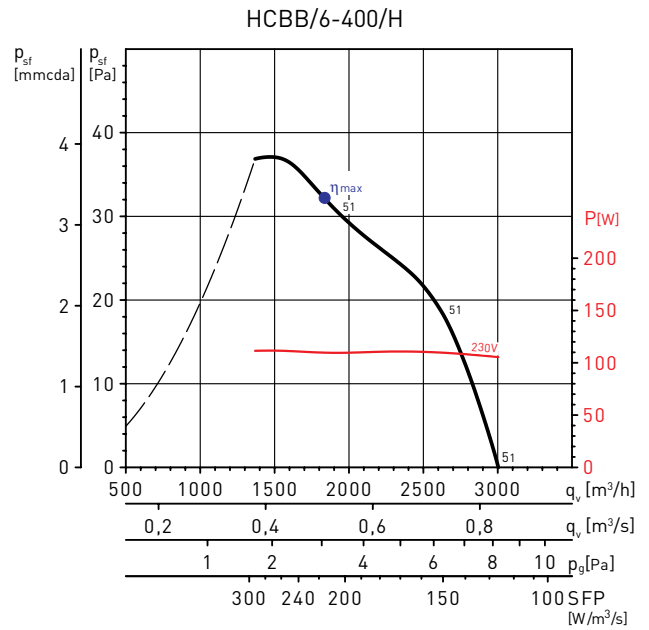
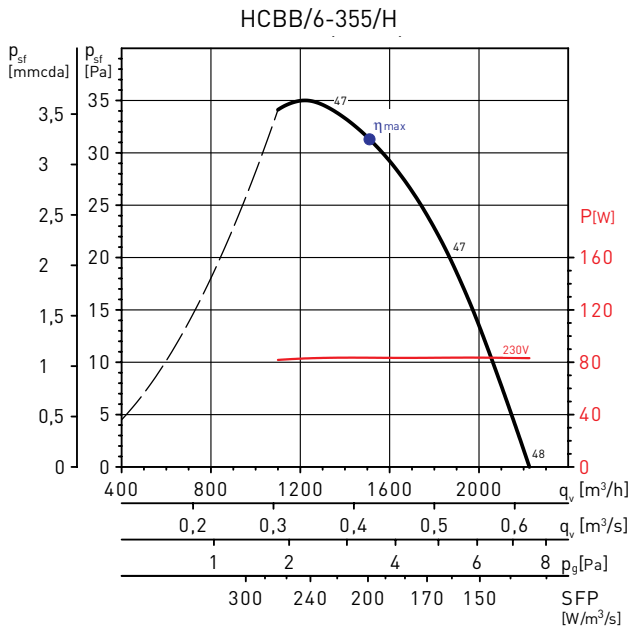

MC	EC	VSD	SR	η [%]	N	[kW]	[m^3/h]	[Pa]	[RPM]
A	Static	No	1	29,3	40,2	0,190	2604	77	908

MC	EC	VSD	SR	η [%]	N	[kW]	[m^3/h]	[Pa]	[RPM]
A	Static	No	1	29,9	40,1	0,244	3660	72	886

CURVAS CARACTERÍSTICAS - MOTORES DE 6 POLOS

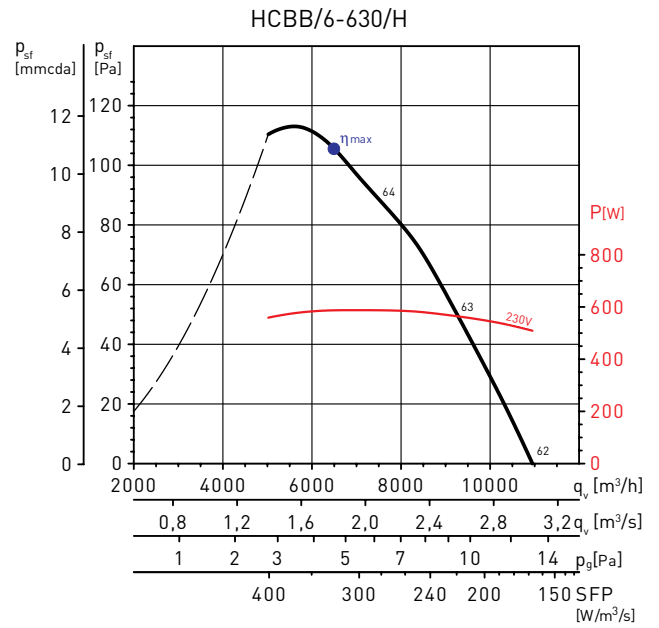
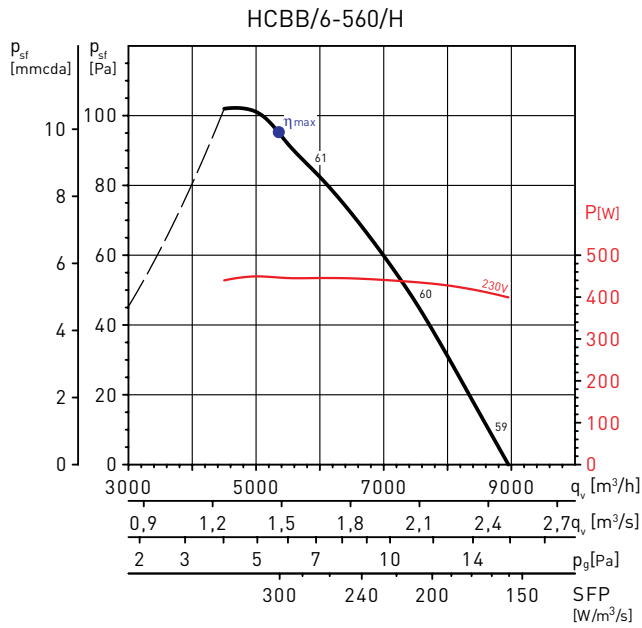

MC	EC	VSD	SR	η [%]	N	[kW]	[m^3/h]	[Pa]	[RPM]
A	Static	No	1	31,6	40,1	0,447	5347	95	903

MC	EC	VSD	SR	η [%]	N	[kW]	[m^3/h]	[Pa]	[RPM]
A	Static	No	1	32,4	40,2	0,587	6492	106	888

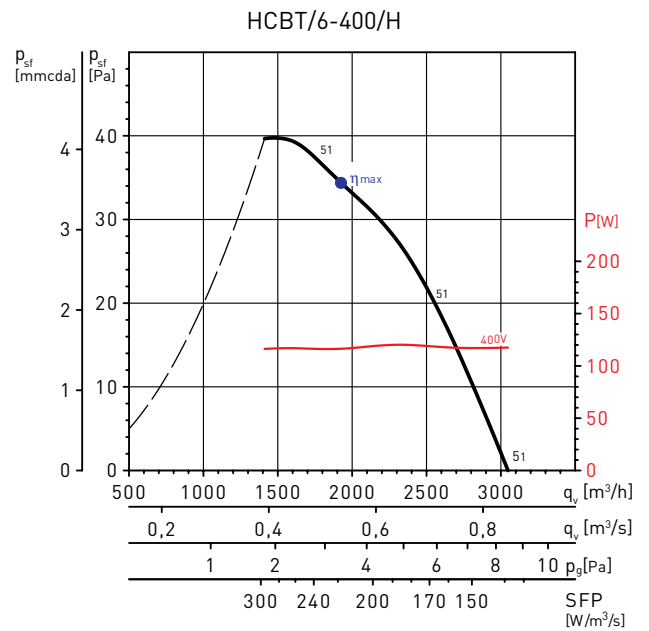
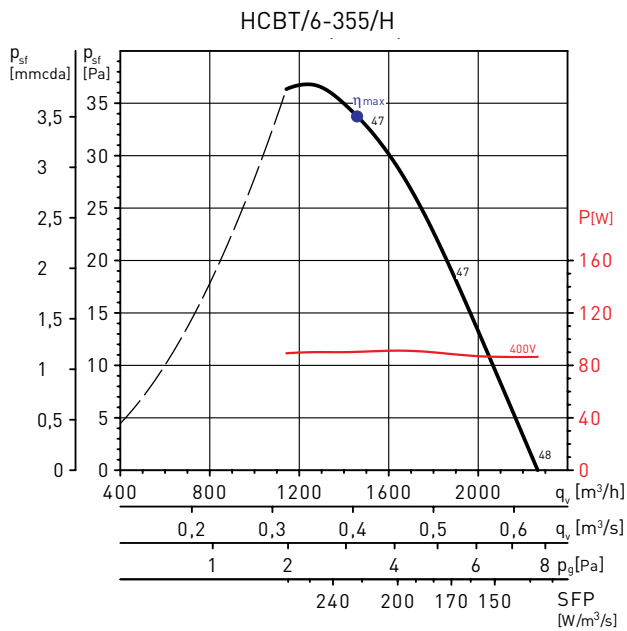

CURVAS CARACTERÍSTICAS - MOTORES DE 6 POLOS

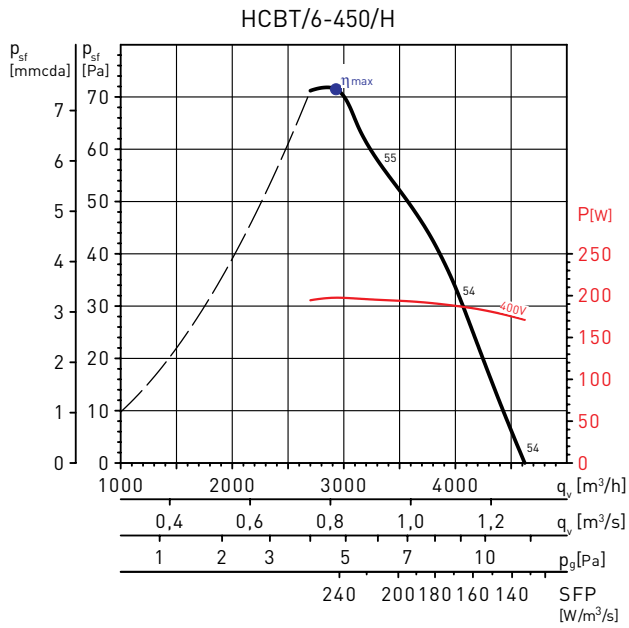

MC	EC	VSD	SR	η [%]	N	[kW]	[m^3/h]	[Pa]	[RPM]
A	Static	No	1	29,3	40,1	0,198	2925	71	904

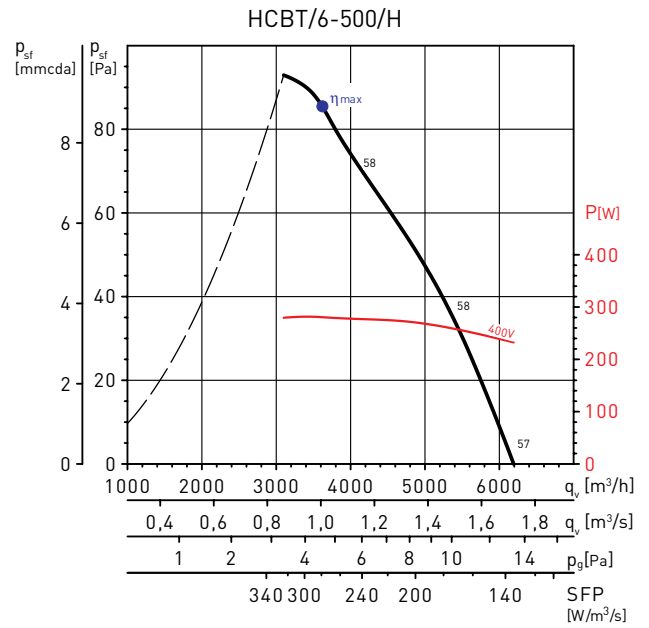

MC	EC	VSD	SR	η [%]	N	[kW]	[m^3/h]	[Pa]	[RPM]
A	Static	No	1	30,3	40,1	0,281	3613	85	874

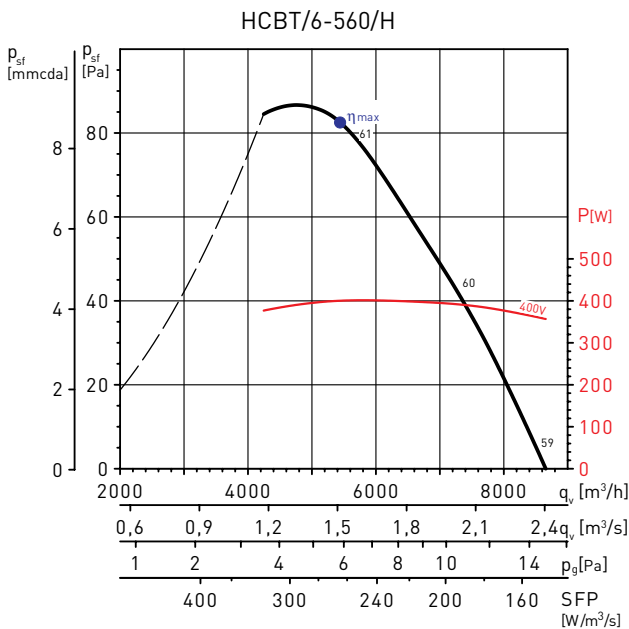

MC	EC	VSD	SR	η [%]	N	[kW]	[m^3/h]	[Pa]	[RPM]
A	Static	No	1	31,2	40,0	0,400	5444	83	876

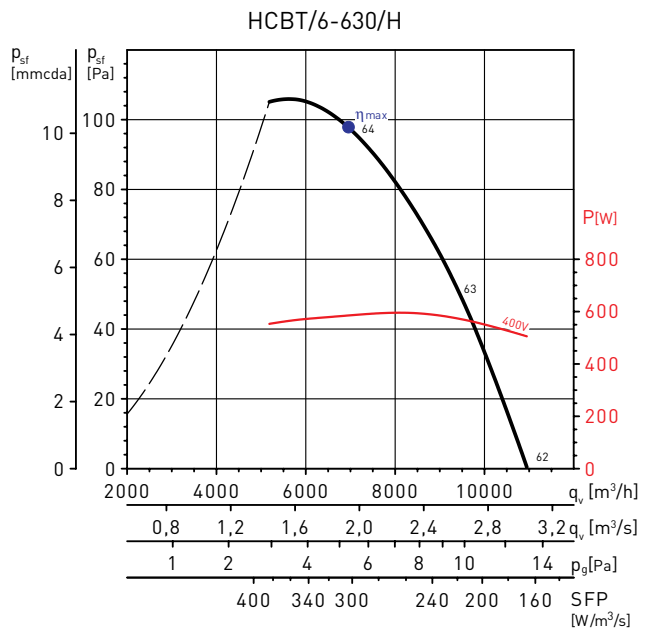

MC	EC	VSD	SR	η [%]	N	[kW]	[m^3/h]	[Pa]	[RPM]
A	Static	No	1	32,3	40,1	0,585	6954	98	889

CURVAS CARACTERÍSTICAS - MOTORES DE 6 POLOS

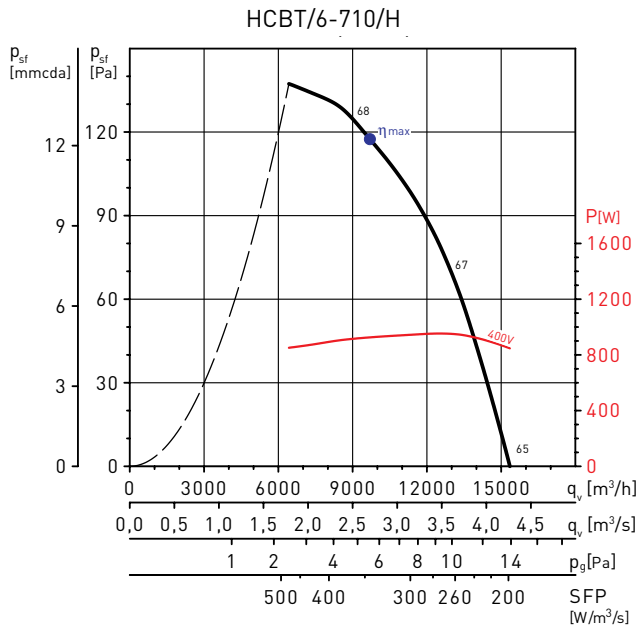

MC	EC	VSD	SR	η [%]	N	[kW]	[m^3/h]	[Pa]	[RPM]
A	Static	No	1	34,2	40,7	0,926	9683	118	946

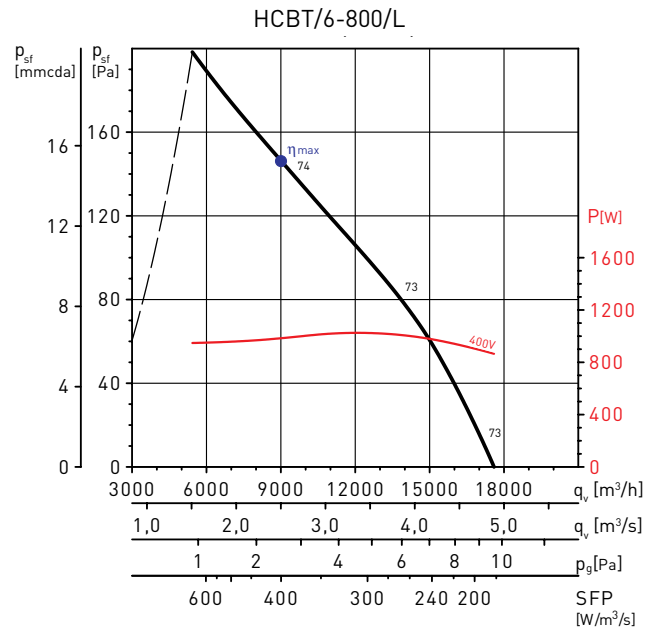

MC	EC	VSD	SR	η [%]	N	[kW]	[m^3/h]	[Pa]	[RPM]
A	Static	No	1	37,2	43,6	0,984	9004	146	927

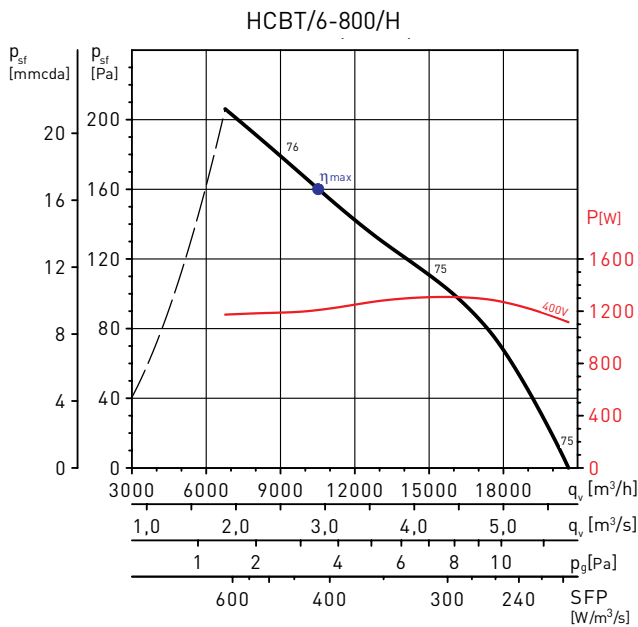

MC	EC	VSD	SR	η [%]	N	[kW]	[m^3/h]	[Pa]	[RPM]
A	Static	No	1	38,8	44,6	1,208	10519	160	923

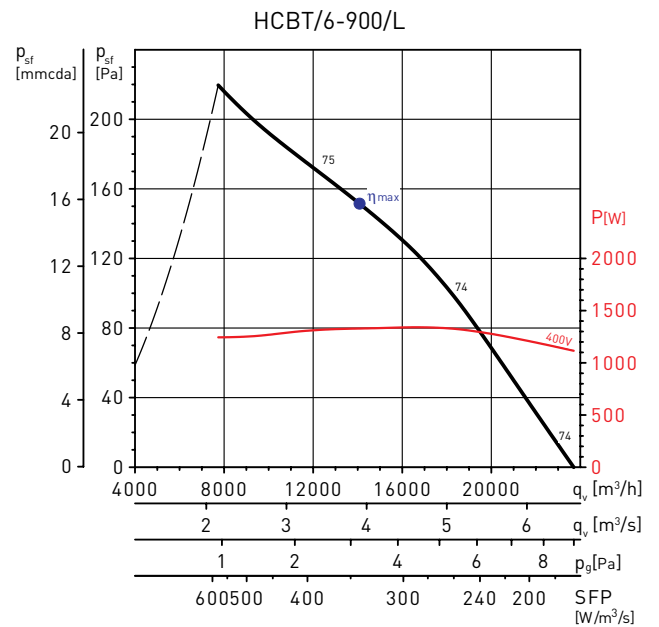

MC	EC	VSD	SR	η [%]	N	[kW]	[m^3/h]	[Pa]	[RPM]
A	Static	No	1	44,6	50,2	1,329	14066	152	953

CURVAS CARACTERÍSTICAS - MOTORES DE 6 POLOS

HCBT/6-900/H

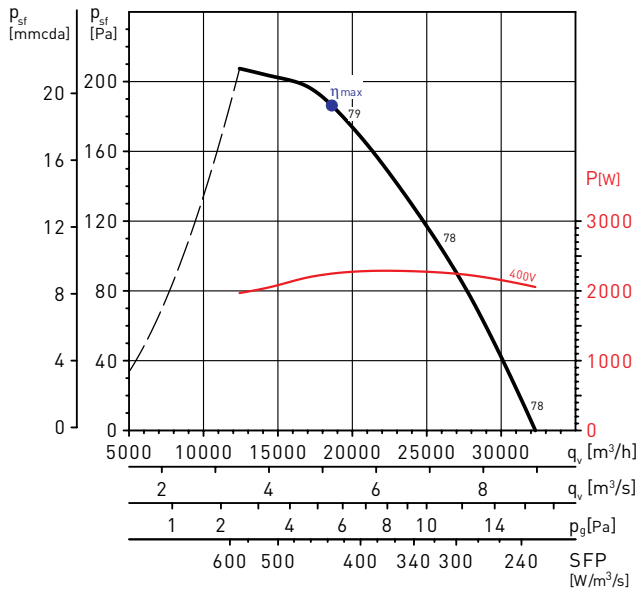

MC	EC	VSD	SR	η[%]	N	[kW]	[m³/h]	[Pa]	[RPM]
A	Static	No	1	42,8	46,9	2,247	18590	187	943

HCBT/6-1000/L

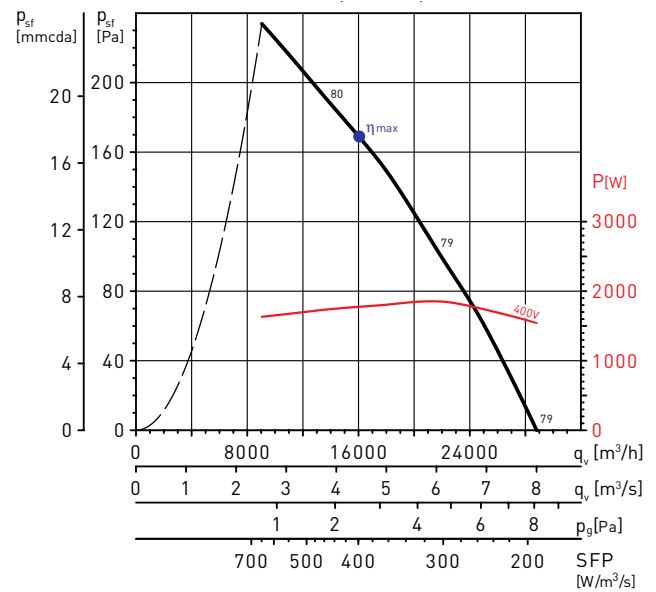

MC	EC	VSD	SR	η[%]	N	[kW]	[m³/h]	[Pa]	[RPM]
A	Static	No	1	42,4	47,2	1,775	16021	169	927

HCBT/6-1000/H

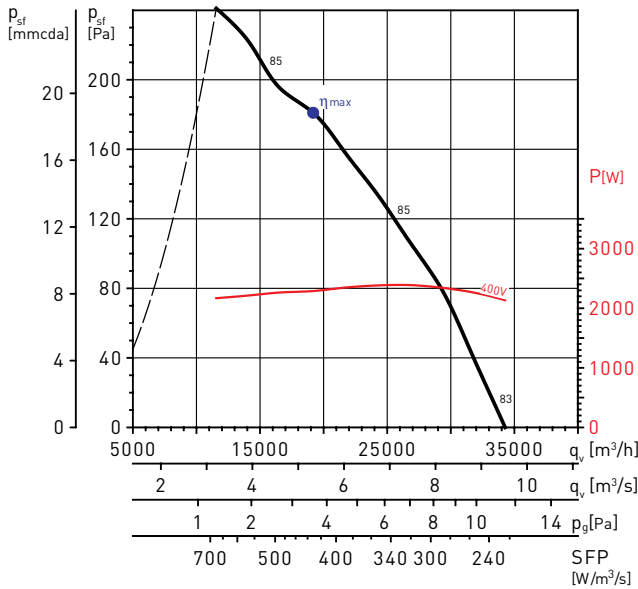

MC	EC	VSD	SR	η[%]	N	[kW]	[m³/h]	[Pa]	[RPM]
A	Static	No	1	42,1	46,2	2,288	19168	181	930